

Product overview



Table of contents

	Page		Page
01 Baskets and containers	8	04 Medical furnishings	178
Sterile goods baskets	10	Packing and work tables	190
Accessories for sterile goods baskets	19	Light tables	197
Instrument baskets	22	Sink units	198
Accessories for instrument baskets	28	Cabinets	201
Fine mesh baskets	33	Operating theatre steps	207
Special baskets	34	Hygiene range	208
Containers	38		
02 Transport solutions	42	05 Waste/laundry collector	212
Känguruh System	44	Waste/laundry collector	214
Container and sterile goods transport carts	52	Theatre laundry/waste collector	216
Hook system	62	Accessories for theatre laundry/waste collectors	217
Attachments	70		
Transport trolleys	82		
Accessories for general purpose trolleys	89		
Special transport trolleys	91		
03 Shelving systems	98		
Norm 5 stationary shelving	102		
Norm 5 Medidul stationary shelving	122		
Norm 25 stationary shelving	128		
Norm 20 stationary shelving	134		
Norm 12 stationary shelving	150		
Easy Rider systems	162		
Mobile shelving	168		
Wall shelving	174		

Our most successful product is customer satisfaction



Our success story began with metalworking and wire mesh production, and we have added many exciting new chapters to it over the years. Our philosophy and actions have always been determined by our understanding of quality, our instinctive grasp of precision and our aspiration to always offer the best possible solutions.

We have continually grown along with the challenges and expectations of our customers. Today Hupfer is a specialist for kitchen and sterile supplies logistics, offering bespoke "Made in Germany" concepts appreciated by more and more customers around the world.



Outstanding quality down to the finest detail

Quality is our unmistakable trademark, from material and workmanship right through to functionality, safety, service and punctual delivery. We ensure this with our state-of-the-art planning and manufacturing technology, carefully chosen suppliers and partners, and comprehensive quality assurance.

But above all it is our highly trained employees who characterise the Hupfer brand. From development to delivery, they build every product using their expertise and craftsmanship, ensuring Hupfer quality right down to the finest detail.



Tested safety right from the start

Hupfer is a developer and manufacturer of Class I medical devices and has a certified management system according to ISO 9001 and ISO 13485. Our solutions guarantee the highest quality and functional reliability from technology to service.

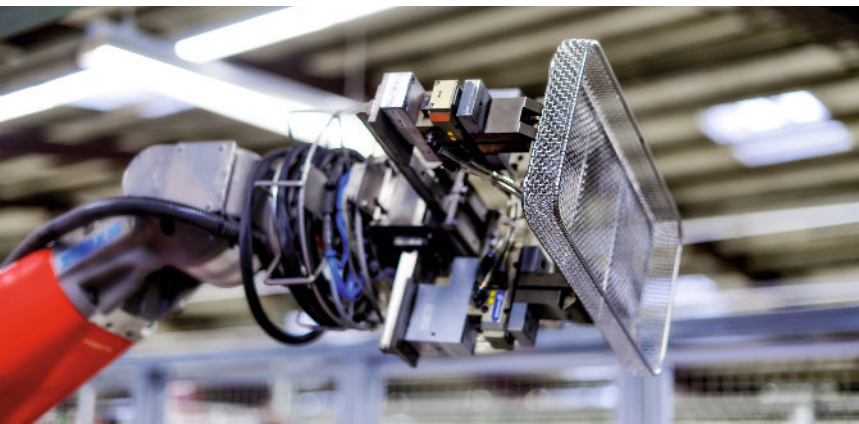
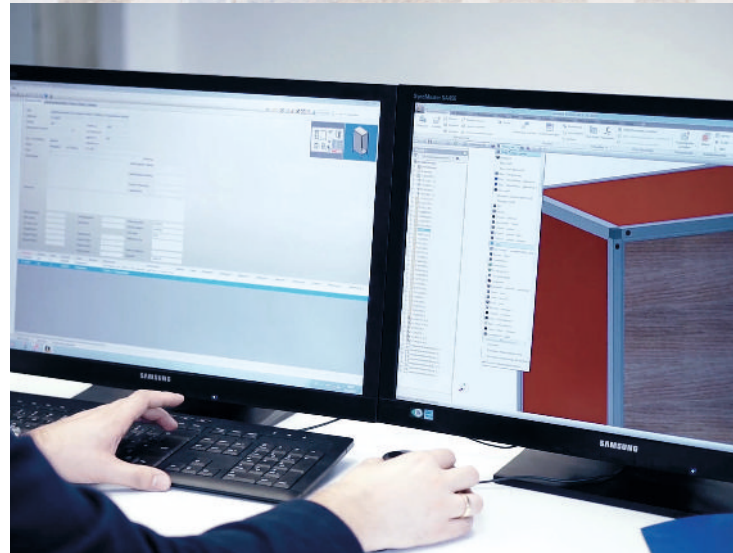

Your partner for innovative sterile supplies logistics



At Hupfer we develop our products and systems based on a deep understanding of the logistical structures and individual requirements of clinics and medical departments.

As specialists for sterile supplies logistics, we offer integrated solutions for supplying and disposing of sterile goods. Whether packaging, sterilising, transporting, storing, distributing, cleaning or disinfecting – Hupfer helps you optimise work processes, increase occupational safety and guarantee the highest standards of hygiene for cleaning, disinfecting and sterilising.

With decades of experience, in-depth knowledge of the industry and comprehensive solutions, we support planners, specialist dealers and users, so that everyone involved can be sure that they can achieve the goals we all share: safety, cost-effectiveness and genuinely satisfied customers, including the patients.

Your active designer throughout the entire logistics cycle



When it comes to efficiency, Hupfer defines itself as a maker, an active designer with a focus on holistic solutions and less on the individual product.

As "efficiency makers", we not only want to develop economical products, but we also want to do so as efficiently as possible. But when exactly is an activity efficient? In short, When you achieve your goals with little effort. Hupfer offers efficient solutions along the entire process chain in sterile supplies logistics.

Baskets and containers



Careful and structured handling of sterile supplies is the basis for many crucial processes in clinics, hospitals and sterilisation facilities. Hupfer offers a comprehensive range of baskets and containers for a wide variety of applications and requirements. They meet the highest quality standards from the material to the workmanship and guarantee optimum functionality and safety in daily use.



Sterile goods baskets



Excellent products with decisive advantages

Wire sterile goods baskets are used for transporting and storing sterile supplies in soft packaging. Some designs can be used in cabinet systems as well as in shelving systems or in combination with wall-mounted hook rails. They are also used in combination with transport trolleys and transport carts.

Hupfer sterile goods baskets are made of high-quality, electropolished stainless steel, are designed for a rough everyday life and are manufactured with care and precision for safe handling, durability and easy cleaning.





Whether stackable inside or on top of each other or for hanging on wall-mounted hook rails – our comprehensive range of sterile goods baskets has the right solution for every requirement and area of use.

- Completely hygienic, protected transport
- Space-saving storage
- Practical provision
- Edge protection for safer handling

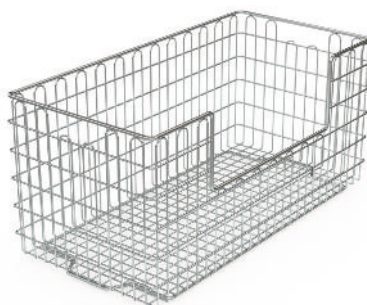

Sterile goods baskets



Sterile goods basket – stackable inside and on top of each other

These sterile goods baskets are designed to ensure a rapid workflow while requiring little space. They can be stacked inside each other to save space at the packing table, and then stacked on top of each other once filled. The sophisticated, carefully manufactured wire mesh structure is ideal for safe handling, stability, optimum cleaning and hygiene. Large quantities of empty baskets can be neatly stacked deep into each other, then cleaned and disinfected in a single process.



Sterile goods basket for StU

- Stackable inside and on top of each other
- With fold-down handles
- Not compatible with U-shaped rails

	Dimensions W × D × H mm	Product code
SteriKo StE-1/1 600/292/260 KG	600 × 292 × 260	7501870
SteriKo StE-1/2 600/292/138 KG	600 × 292 × 138	7501871
SteriKo StE-1/2 600/292/138 KG mE	600 × 292 × 138	7501165



Insertable sterile goods basket for StU

- With U-shape profile rail compatible drawer frame
- Stackable inside and on top of each other
- With fold-down handles

	Dimensions W × D × H mm	Product code
SteriKo StE-1/1 600/300/260 KG SchR	600 × 300 × 260	7500011
SteriKo StE-1/2 600/300/138 KG SchR	600 × 300 × 138	7500012
SteriKo StE-1/3 600/300/97 KG SchR	600 × 300 × 97	7500013



Insertable sterile goods basket for ISO standard

- With U-shape profile rail compatible drawer frame
- Stackable inside and on top of each other

	Dimensions W × D × H mm	Product code
SteriKo ISO-1/2 600/400/130 SchR	600 × 400 × 130	7214015
SteriKo ISO-1/2 600/400/150 SchR	600 × 400 × 150	7214016
SteriKo ISO-1/3 600/400/100 SchR	600 × 400 × 100	7214005
SteriKo ISO-2/3 600/400/180 SchR	600 × 400 × 180	7214006



Insertable sterile goods basket for SPRI

- With U-shape profile rail compatible drawer frame
- Stackable inside and on top of each other
- With fold-down handles

	Dimensions W × D × H mm	Product code
SteriKo Spri-1/1 585/395/195 KG	585 × 395 × 195	7593508
SteriKo Spri-1/2 585/395/100 KG	585 × 395 × 100	7593507

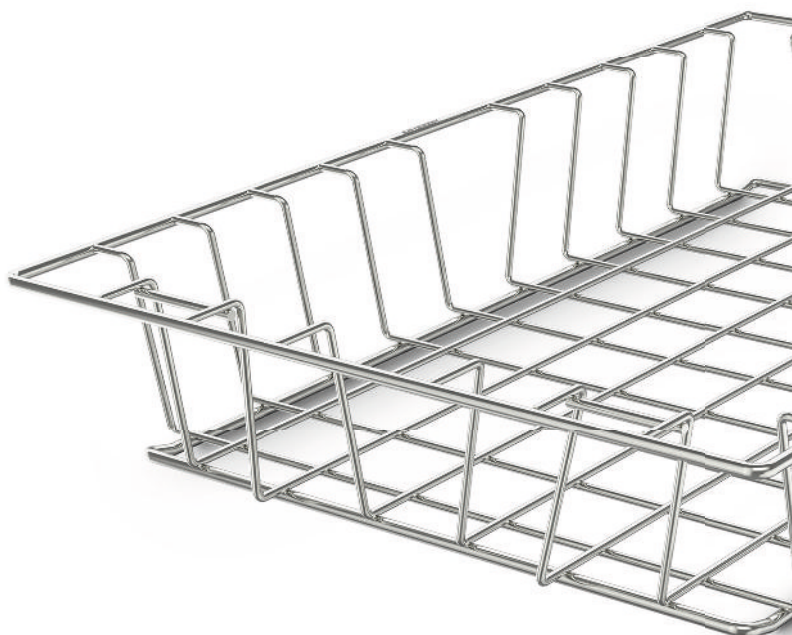

Sterile goods baskets

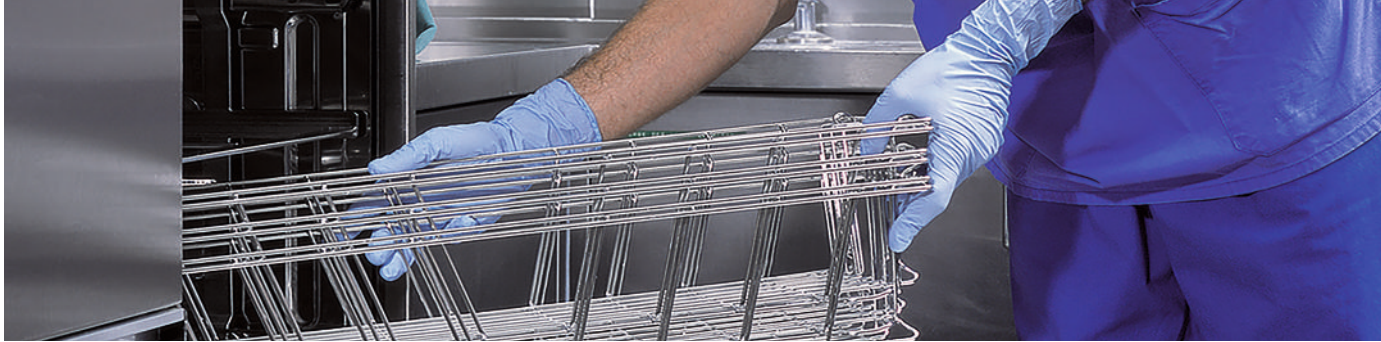

ErgoSlide® sterile goods basket – stackable with innovative slide rail

The Hupfer ErgoSlide series offers extra safety and ergonomics in sterile supplies logistics. Thanks to the side rails, the baskets can be slid over each other and taken again without the upper basket slipping into the one below. For stacking, the slide rails are simply folded outwards or inwards. The robust hinges can be easily checked for dirt and cleaned if necessary.



ErgoSlide® sterile goods basket for StU

- Stackable inside and on top of each other
- With folding handles on sides with slide rail function
- not compatible with U-shape profile rails

	Dimensions W × D × H mm	Product code
SteriKo StE-1/1 600/292/260 ERGO KG	600 × 292 × 260	7501862
SteriKo StE-1/2 600/292/138 ERGO KG	600 × 292 × 138	7501860
SteriKo StE-1/2 600/292/150 ERGO KG	600 × 292 × 150	7501861
SteriKo StE-1/3 600/292/97 ERGO KG	600 × 292 × 97	7501863

Sterile goods basket – stackable on top of each other

Stacked on top of each other, these baskets allow clearly arranged provision of working material and sterile supplies. For quick access to the stored sterile items, you will find the baskets optionally with handle openings, engagement openings or engagement slopes. Baskets filled with sterile supplies can be stacked on top of each other without any problems. They are also suitable for hanging on wall-mounted hook rails, hook frames and hook trolleys.



Sterile goods basket with access opening from above ...



... with inclined access opening ...



... with broadside access opening.



Perfectly arranged: sterile supplies always at hand

Sterile goods baskets

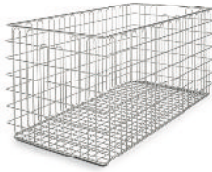

Sterile goods basket for StU – with handle opening

- Stackable on top of each other

	Dimensions W × D × H mm	Product code
SteriKo StE-1/1 575/280/265 GrÖ	575 × 268 × 280	7500017
SteriKo StE-1/1 600/300/300 GrÖ	600 × 300 × 300	7500020
SteriKo StE-1/2 575/280/135 GrÖ	575 × 138 × 280	7500016
SteriKo StE-1/2 600/300/150 GrÖ	600 × 300 × 150	7500021
SteriKo StE-2/1 575/560/265 GrÖ	575 × 560 × 265	7500019



Sterile goods basket for ISO – with handle opening

- Stackable on top of each other

	Dimensions W × D × H mm	Product code
SteriKo ISO-1/1 600/400/300 GrÖ	600 × 400 × 300	7500626
SteriKo ISO-1/2 600/400/150 GrÖ	600 × 400 × 150	7500625



Sterile goods basket for StU – with access opening

- Stackable on top of each other

	Dimensions W × D × H mm	Product code
SteriKo StE-1/1 575/280/265 GrÖ EÖ	575 × 268 × 280	7500018
SteriKo StE-1/1 600/300/300 GrÖ EÖ	600 × 300 × 300	7500022



Sterile goods basket for ISO – with access opening

- Stackable on top of each other

	Dimensions W × D × H mm	Product code
SteriKo ISO-1/1 600/400/300 GrÖ EÖ	600 × 400 × 300	7500969



Sterile goods basket for StU – with inclined access opening

- Stackable on top of each other

	Dimensions W × D × H mm	Product code
SteriKo StE-1/2 575/280/135 GrÖ ES	575 × 138 × 280	7500148
SteriKo StE-1/2 600/300/150 GrÖ ES	600 × 300 × 150	7500301



Sterile goods baskets

Sterile goods basket for 1/6 StU

This special basket is designed for holding and storing instruments and large trays. It is suitable for Norm 5 Medidul shelving systems, cabinet systems with L rails and use in the Hupfer Känguruh System.



Stackable sterile goods basket for StU

- With push frame
- Edge protection for safety

	Dimensions W × D × H mm	Product code
SteriKo StE-1/6 600/300/44	600 × 300 × 44	7501508

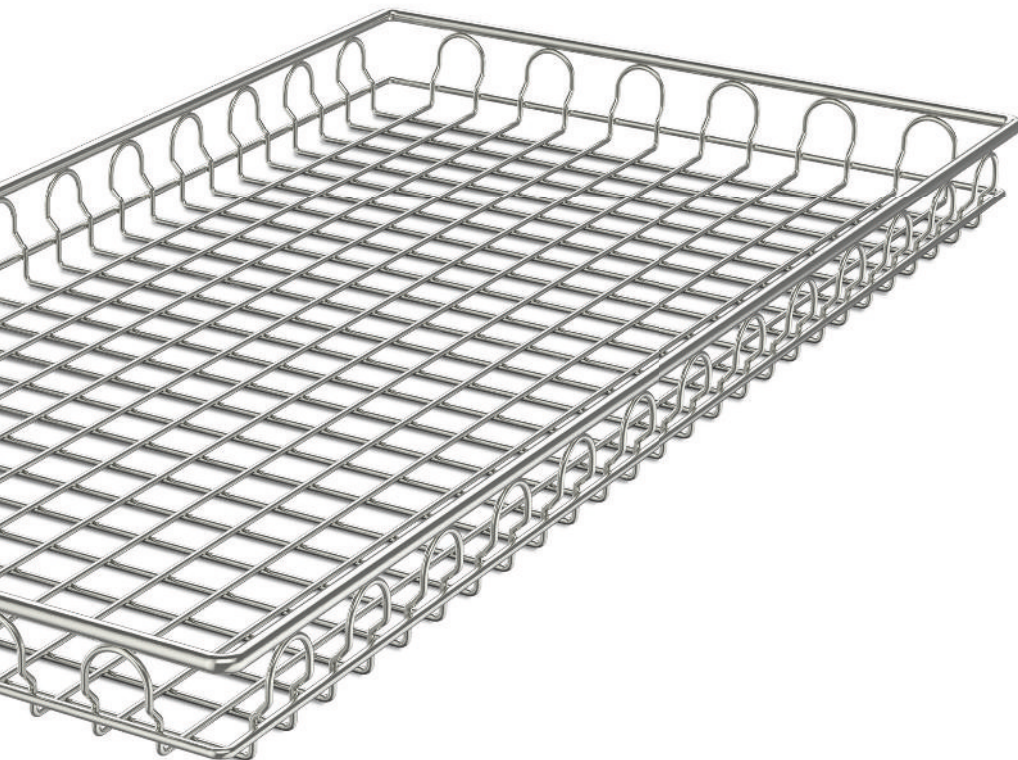

Accessories for sterile goods baskets



Accessories for sterile goods baskets

With useful and practical accessories, the functionality and handling of sterile goods baskets can be individually extended according to how and where they are used. From dividers to damage protection clips, our range of accessories has first-class solutions for every requirement.



Basket divider – crosswise

- Wire thickness: Ø 2.5 mm
- Optimum use of the storage space
- Quick adjustment
- Effortless hooking in and removal
- Optimum hygiene



	for product	Dimensions W × D × H mm	Product code
QT 262/126/9	7500148	262 × 126 × 9	7500149
QT 278/118/5	7500016	278 × 118 × 5	7500218
QT 278/241/8	7500017	278 × 241 × 8	7500219
QT 298/126/5	7500021	298 × 126 × 5	7500220
QT 298/271/8	7500020	298 × 271 × 8	7500221



Basket divider for baskets with inclined access opening

- Wire thickness: Ø 2.5 mm
- Optimum use of the storage space
- Quick adjustment
- Effortless hooking in and removal
- Optimum hygiene



	for product	Dimensions W × D × H mm	Product code
TG 282/141/8	7500301	282 × 141 × 8	7500516
TG 398/121/8	7500625	398 × 121 × 8	7500517

Accessories for sterile goods baskets



Basket divider – lengthwise

- Wire thickness: Ø 2.5 mm
- Optimum use of the storage space
- Quick adjustment
- Effortless hooking in and removal
- Optimum hygiene



	for product	Dimensions W × D × H mm	Product code
LT 600/150/20	7500021	598 × 20 × 126	7502949
LT 600/300/20	7500020, 7500022	597 × 271 × 20	7502950



Damage protection clip

- Suitable for baskets with wire thickness 3.5 mm
- Specially suitable for sterile goods basket ErgoSlide and sterile goods basket StU
- Prevents perforation



	Dimensions W × D × H mm	Product code
AufKl 110/25/10	110 × 25 × 10	7500279



Label holder

- Optimised logistics
- Reliable mounting
- Simple adjustment
- Maximum hygiene



	Dimensions W × D × H mm	Product code
KS 103/80/6	103 × 80 × 6	7500155
KS 106/102/6	106 × 102 × 6	7505981
KS 106/83/6	106 × 83 × 6	7505980

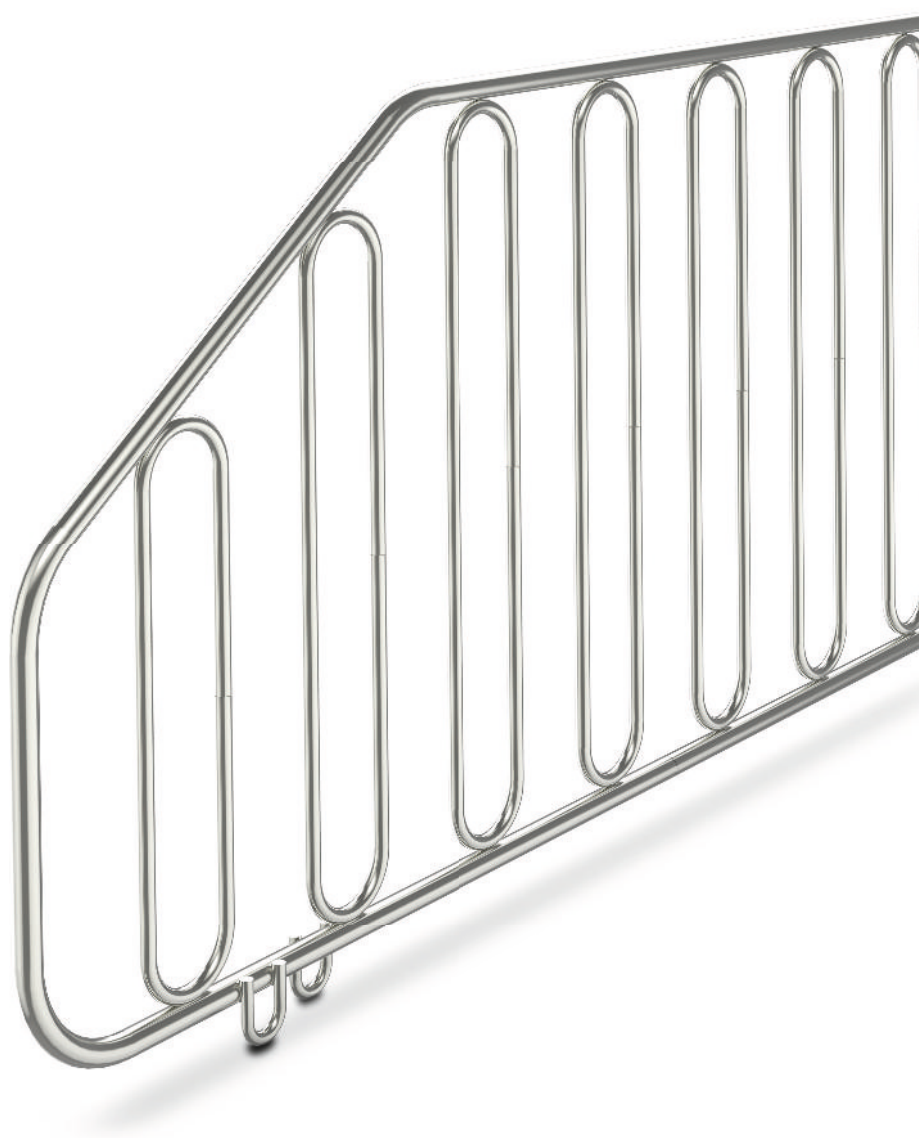

Instrument baskets



Hupfer instrument baskets

Hupfer instrument baskets are manufactured to the highest quality standards and meet the strict safety requirements for everyday clinical practice. Because they are carefully manufactured with smooth edges and corners, they not only provide optimum protection for instruments and soft packaging, but also safety for staff and patients during handling. The sturdy design guarantees high loading capacity and outstanding durability.



Quality with smooth edges and corners

The careful manufacturing of Hupfer instrument baskets increases safety during daily work – to protect employees and sensitive materials.

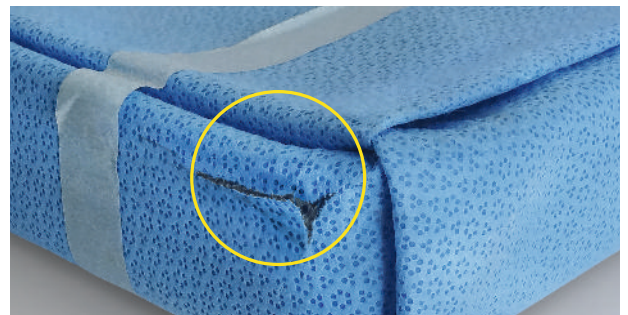

Hupfer instrument baskets with mesh

- Burr-free top frame without sharp edges and corners and tips
- Smooth wire mesh protects the stored material
- Tissue size for optimal cleaning and drying designed
- Floor struts for high loading capacity
- Sturdy corner struts to protect from damages



Stackable instrument basket with stacking frame

- 100% connection of the floor grid through welding of each individual wire
- Upper frame welded to perforated plate
- Fine-perforated, burr-free perforated plate for the protection against puncturing of fine and pointed instruments
- Reliable cleaning and drying due to optimised hole size in wall and base
- Floor struts for high loading capacity



Hupfer instrument baskets with perforated sides

- Version without base frame to reduce condensation water
- Wide-area weight distribution for optimal protection of the soft packaging
- Upper frame welded to perforated plate
- Finely perforated, burr-free perforated plate to protect against puncturing fine and pointed instruments
- Ideally suited for the use of soft packaging as a sterile barrier system



Instrument baskets

Instrument baskets

Hupfer instrument baskets are made of high-quality electropolished round stainless steel wire and are hygienic and easy to clean. The special shape of the base frame means the instrument basket can be safely and neatly stacked on top of each other. The internal drop handles on the short sides make them particularly easy to handle.



Instrument basket with drop handles

- With stacking frame
- Mesh size: 4.64 × 4.64 mm

	Dimensions W × D × H mm	Product code
SiSch 240/250/50 SR FG DM	240 × 50 × 250	7500053
SiSch 240/250/70 SR FG DM	240 × 70 × 250	7500046
SiSch 240/254/50 SR FG DM	240 × 50 × 254	7500001
SiSch 480/250/100 SR FG DM	480 × 100 × 250	7500049
SiSch 480/250/50 SR FG DM	480 × 50 × 250	7500059
SiSch 480/250/70 SR FG DM	480 × 70 × 250	7500048
SiSch 480/254/50 SR FG DM	480 × 50 × 254	7500004
SiSch 510/254/50 SR FG DM	510 × 50 × 254	7500065
SiSch 540/252/60 SR FG DM	540 × 60 × 252	7500070



Lid for instrument baskets with drop handles

- With twist lock
- electropolished stainless steel

	For product	Dimensions W × D × H mm	Product code
De 250/240/16	7500046, 7500053	250 × 240 × 16	7500912
De 480/250/16	7500048, 7500049, 7500059	480 × 250 × 16	7500911



Instrument basket with fold down handles

- With stacking frame
- Mesh size: 4.64 × 4.64 mm

	Dimensions W × D × H mm	Product code
SiSch 240/250/50 SR KG DM	240 × 63 × 250	7500071
SiSch 480/250/50 SR KG DM	480 × 63 × 250	7500073
SiSch 480/254/50 SR KG DM	480 × 63 × 254	7500074



Double basket

- With stacking frame
- With locking handle
- Mesh size: 4.64 × 4.64 mm

	Dimensions W × D × H mm	Product code
SiSch/VER 265/250/100 SR VG DM	265 × 100 × 250	7501187
SiSch/VER 505/250/100 SR VG DM	504 × 100 × 250	7501188



Stackable instrument basket

- With stacking frame
- Mesh size: 6.5 × 6.5 mm
- Side panel mesh size: 6.5 × 7.5 mm

	Dimensions W × D × H mm	Product code
SiKo 250/170/70 SR oG SG	250 × 170 × 70	7501158
SiKo 340/250/70 SR oG SG	340 × 250 × 70	7501159
SiKo 450/340/70 SR oG SG	450 × 340 × 70	7501160

Instrument baskets



Instrument baskets with perforated sides

With high-quality perforated sides, Hupfer instrument baskets offer particular protection from damage. This means they are suitable for very fine, pointed and conically tapered instruments as well as for sensitive soft packaging. The bottoms made of welded mesh ensure optimum drainage and ensure that no areas are missed when cleaning and disinfecting.



Instrument basket

- Mesh size: 6 × 6 mm
- Perforated plate thickness: 0.8 mm
- Without stacking frame



	Dimensions W × D × H mm	Product code
SiKo 320/115/60 oR LB/SG	320 × 115 × 60	7500683

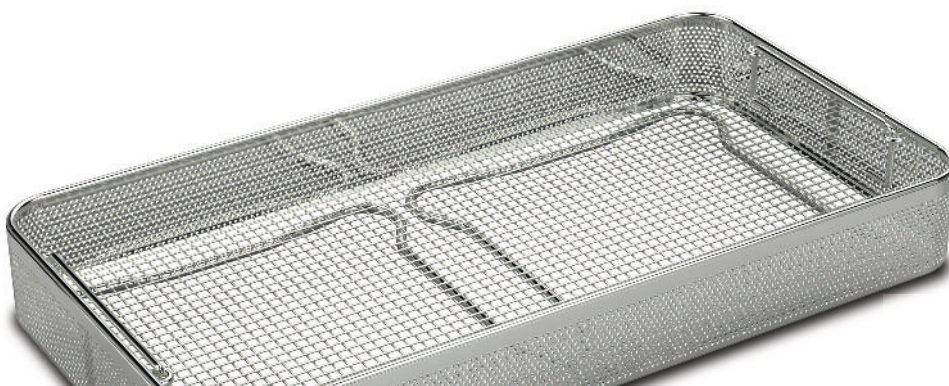

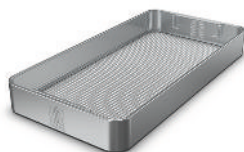

Instrument basket with drop handles

- Mesh size: 6 × 6 mm
- Perforated plate thickness: 0.8 mm
- Without stacking frame

	Dimensions W × D × H mm	Product code
SiKo 120/250/60 oR FG LB/SG	250 × 120 × 60	7500809
SiKo 240/250/60 oR FG LB/SG	250 × 240 × 60	7500645
SiKo 320/230/60 oR FG LB/SG	320 × 230 × 60	7500730
SiKo 360/250/60 oR FG LB/SG	360 × 250 × 60	7515007
SiKo 480/250/100 oR FG LB/SG	480 × 250 × 100	7515006
SiKo 480/250/60 oR FG LB/SG	480 × 250 × 60	7500599
SiKo 480/300/60 oR FG LB/SG	480 × 300 × 60	7500729
SiKo 520/270/60 oR FG LB/SG	520 × 270 × 60	7501655
SiKo 550/250/60 oR FG LB/SG	550 × 60 × 250	7504799
SiKo 600/250/60 oR FG LB/SG	600 × 60 × 250	7501650



Stackable instrument basket with drop handles

- With stacking frame
- Mesh size: 6 × 6 mm
- Perforated plate thickness: 0.8 mm

	Dimensions W × D × H mm	Product code
SiKo 240/250/66 SR FG LB/SG	250 × 240 × 66	7501295
SiKo 480/250/66 SR FG LB/SG	480 × 250 × 66	7501296
SiKo 510/250/66 SR FG LB/SG	510 × 250 × 66	7501297

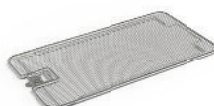

Lid for instrument baskets with drop handles

- With twist lock
- Electropolished stainless steel

	for product	Dimensions W × D × H mm	Product code
De 240/250/16	7500645, 7501295	250 × 240 × 16	7515645
De 480/250/16	7500599, 7515006	477 × 248 × 16	7515599

Accessories for instrument baskets

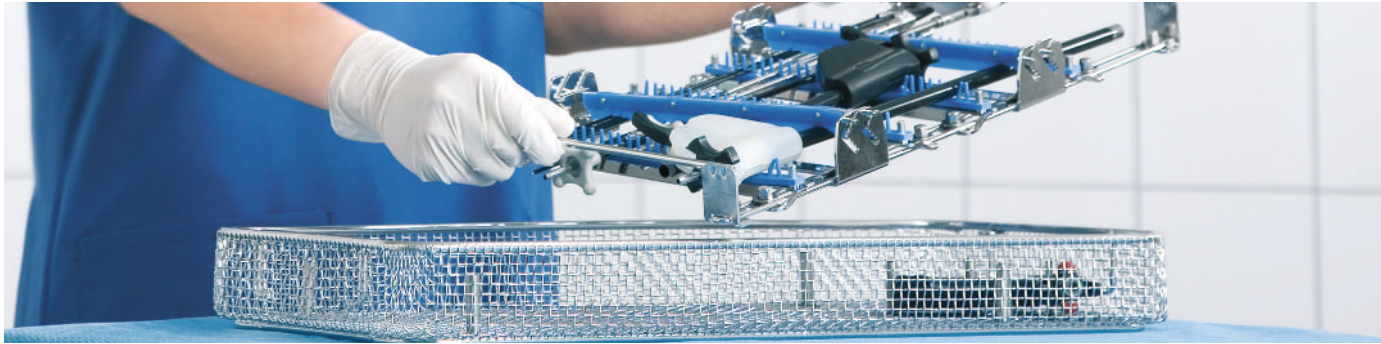

1-2-3-Rack instrument fixing set

This range of accessories offers perfectly fitted solutions for the protection, safe storage and provision of sensitive instruments. With the 1-2-3-Racks they can be fastened or released with just one movement.

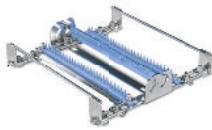

1-2-3-Rack Model 1 instrument fixing set

- For instrument basket with perforated sides
- Suitable for instrument baskets from 240 × 250 mm
- For general instruments
- Electropolished stainless steel



	Dimensions W × D × H mm	Product code
FIX/Instr R1 SiScha/240	231 × 225 × 40	7501397

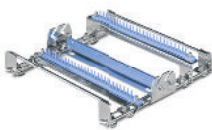

1-2-3-Rack Model 2 instrument fixing set

- For instrument basket with perforated sides
- Suitable for instrument baskets from 240 × 250 mm
- For bayonet instruments
- Electropolished stainless steel



	Dimensions W × D × H mm	Product code
FIX/Instr R2 SiScha/240	231 × 225 × 50	7501398



1-2-3-Rack Model 3 instrument fixing set

- For instrument basket with perforated sides
- Suitable for instrument baskets from 480 × 250 mm
- For general instruments
- Electropolished stainless steel

	Dimensions W × D × H mm	Product code
FIX/Instr R3 SiScha 480	467 × 225 × 40	7501399



1-2-3-Rack Model 4 instrument fixing set

- For instrument basket with perforated sides
- Suitable for instrument baskets from 480 × 250 mm
- For general instruments
- Electropolished stainless steel

	Dimensions W × D × H mm	Product code
FIX/Instr R4 SiScha 480	467 × 225 × 40	7501400

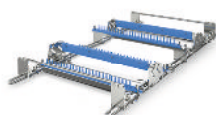

1-2-3-Rack Model 5 instrument fixing set

- For instrument basket with perforated sides
- Suitable for instrument baskets from 480 × 250 mm
- For general and bayonet instruments
- electropolished stainless steel

	Dimensions W × D × H mm	Product code
FIX/Instr R5 SiScha 480	467 × 225 × 40	7501401



1-2-3-Rack Model 6 instrument fixing set

- For instrument basket with perforated sides
- Suitable for instrument baskets from 480 × 250 mm
- For long-shafted instruments
- Electropolished stainless steel

	Dimensions W × D × H mm	Product code
FIX/Instr R6 SiScha 510	460 × 232 × 155	7501402

Accessories for instrument baskets



1-2-3-Rack Model 7 instrument fixing set

- For instrument basket with perforated sides
- Suitable for instrument baskets from 250 × 240 mm
- For shafted instruments
- Electropolished stainless steel



	Dimensions W × D × H mm	Product code
FIX/Instr R7 SiScha 240	232 × 220 × 155	7501421



Continuously adjustable fixing clamp

- Continuously adjustable holder
- From 60 to 220 × 220 × 39 mm
- Electropolished stainless steel



	Dimensions W × D × H mm	Product code
KLVo verst	200 × 44 × 236	7501134



Accessories for instrument baskets

With useful and practical accessories, the functionality and handling of sterile goods baskets can be individually extended according to how and where they are used. From dividers to cable holders, our range of accessories has first-class solutions for every requirement.



Instrument basket divider

- Stable partitioning
- Long life cycle
- Easy handling
- Optimum water circulation

	Dimensions W × D × H mm	Product code
SKT 240/49/15 qu	240 × 52 × 16	7501686
SKT 470/49/15 lä	470 × 52 × 17	7501685

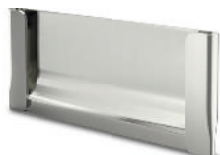

Sign holder for instrument baskets

- Suitable for all instrument baskets
- Bolt-on
- With fixing material

	Dimensions W × D × H mm	Product code
SH 53/25/13	53 × 13 × 25	7500064



Cable holder for instrument baskets

- Package content: 4 units
- Electropolished stainless steel

	Dimensions W × D × H mm	Product code
KabHa 22/42/47	49 × 22 × 42	7501173

Accessories for instrument baskets



Label holder

■ Stainless steel

	Dimensions W × D × H mm	Product code
KS 80/40/10	80 × 40 × 10	7504908

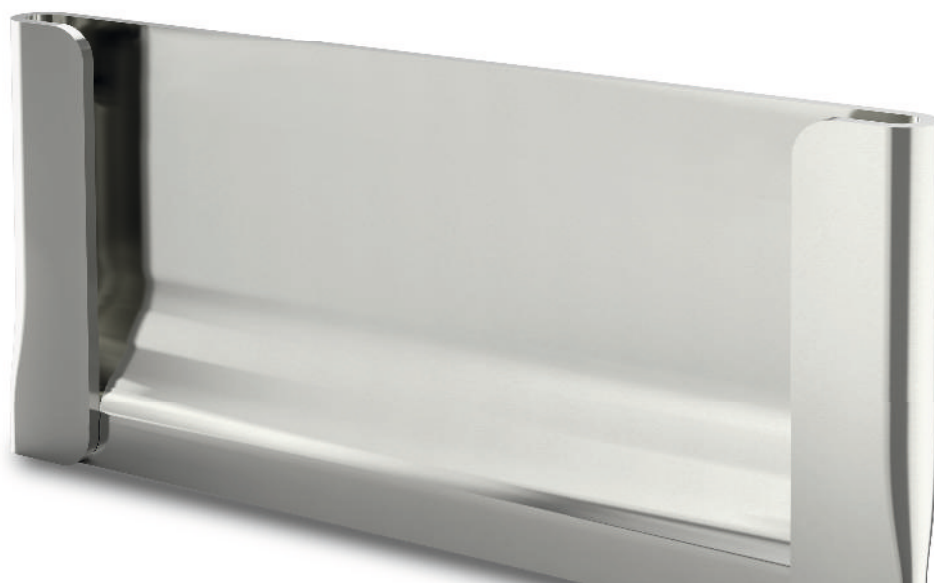

Fine mesh basket

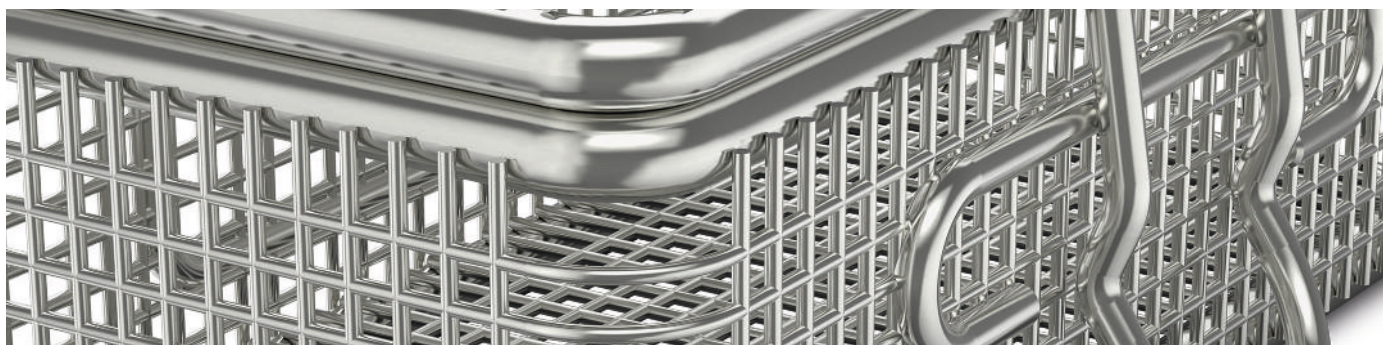

Fine mesh basket

Small parts are safely stored in these wire baskets and can still be optimally cleaned. The lids are securely connected to the baskets and can be opened and closed with one hand.



Fine mesh basket made of stainless steel wire

- With lid
- With base frame
- Mesh size: 1.6 × 1.6 mm

	Dimensions W × D × H mm	Product code
SiKo/KT 200/100/50 BR oG DM mD	200 × 100 × 50	7501204
SiKo/KT 210/150/40 BR oG DM mD	210 × 150 × 40	7501161
SiKo/KT 224/140/54 BR oG DM mD	139 × 54 × 224	7501133
SiKo/KT 274/174/36 BR oG DM mD	274 × 174 × 36	7501135
SiKo/KT 310/210/40 BR oG DM mD	310 × 210 × 40	7501162
SiKo/KT 80/40/32 BR oG DM mD	80 × 40 × 32	7501282
SiKo/KT 80/40/42 BR oG DM mD	80 × 40 × 42	7501220
SiKo/KT 80/80/42 BR oG DM mD	80 × 80 × 40	7501132



Fine mesh basket with perforated sides

- Removable lid
- With base frame
- Sides made of finely perforated plate, base and lid made of welded mesh
- Mesh size: 6 × 6 mm



	Dimensions W × D × H mm	Product code
SiKo/KT 240/250/40 BR oG LB DM mD	250 × 240 × 40	7501150
SiKo/KT 480/250/40 BR oG LB DM mD	480 × 250 × 40	7501151
SiKo/KT 480/250/60 BR oG LB DM mD	480 × 250 × 67	7501153

Special baskets

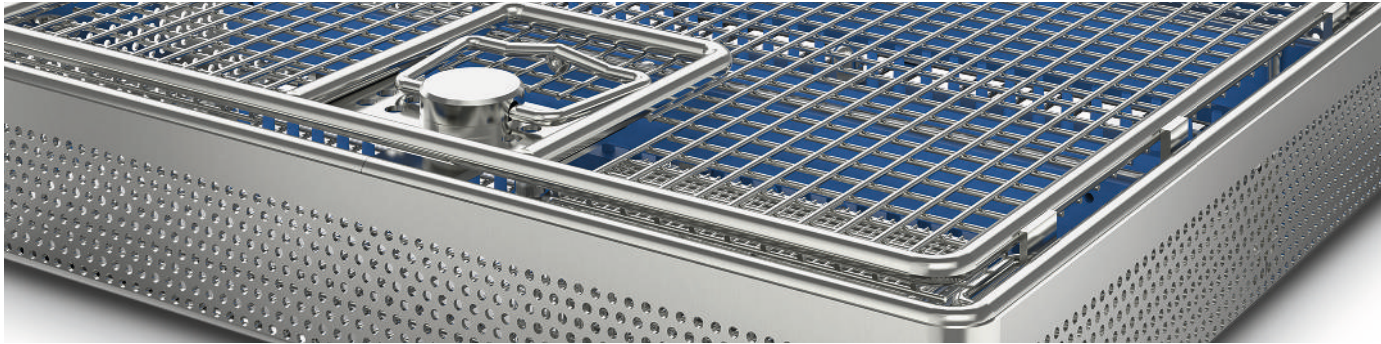

Special basket with instrument fixation

For highly specialised instruments and applications, Hupfer develops mesh baskets and special baskets that are perfectly suited to the situation in the operating room. Instrument baskets are equipped with custom-made holders and lids so that sensitive instruments are optimally fastened and protected at all times. This means they offer the ideal conditions for safe storage, transport and hygienic handling.



Instrument basket for ENT instruments with fine mesh basket

- With instrument holder
- Removable lid
- Includes fine mesh basket
- With perforated sides



	Dimensions W × D × H mm	Product code
SiKo/KT 240/250/40 oR oG LB SG IA mD mKS	250 × 240 × 40	7501349
SiKo/KT 480/250/40 oR oG LB SG IA mD mKS	480 × 250 × 40	7501350



Instrument basket for ENT

- Safe storage of small parts
- Permanent retention of the small parts in the instrument basket
- Maximum hygiene



	Dimensions W × D × H mm	Product code
SiKo/KT 240/250/40 oR oG LB/SG IA mD	250 × 240 × 40	7501717
SiKo/KT 480/250/40 oR oG LB/SG IA mD	480 × 250 × 40	7501723



DaVinci basket for EndoWrist

- With instrument holder and lid
- Electropolished stainless steel

	Dimensions W × D × H mm	Product code
Siko/Endo 680/290/108 oR oG mD 5-fach	680 × 290 × 108	7501874
Siko/Endo 710/110/118 oR oG mD	710 × 110 × 118	7501940



Endoscope basket

- For rigid endoscopes
- Removable lid
- Secured against self-opening
- Secure twist lock
- With silicone inserts

	Dimensions W × D × H mm	Product code
SiKo/Endo 290/80/52 oR oG DS mD 1-fach	290 × 80 × 52	7500479
SiKo/Endo 460/80/52 oR oG DS mD 1-fach	460 × 80 × 52	7500475
SiKo/Endo 670/80/52 oR oG DS mD 1-fach	670 × 55 × 79	7500508

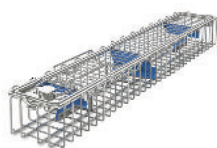

Endoscope basket with 2 compartments

- Removable lid
- Secure twist lock
- With closed wire loops
- With silicone inserts

	Dimensions W × D × H mm	Product code
SiKo/Endo 290/80/52 oR oG DS mD 2-fach	290 × 80 × 52	7500831
SiKo/Endo 460/80/52 oR oG DS mD 2-fach	460 × 80 × 52	7500830



Special baskets

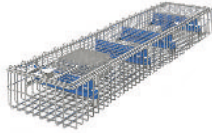

Endoscope basket with optical fibre cable holder

- With fine mesh basket and silicone inserts
- Maximum length of optical fibre: 4500 mm
- Removable lid
- Secure twist lock



	Dimensions W × D × H mm	Product code
SiKo/Endo 640/150/77 oR oG DS mD	640 × 150 × 77	7500849



Endoscope basket with holder for accessories and connections

- With mounting wire for accessories and connections
- Removable lid
- Secure twist lock
- With silicone inserts



	Dimensions W × D × H mm	Product code
SiKo/Endo 290/80/52 oR oG DS mD L-Dr	290 × 80 × 52	7501334
SiKo/Endo 460/80/52 oR oG DS mD L-Dr	460 × 80 × 52	7501336

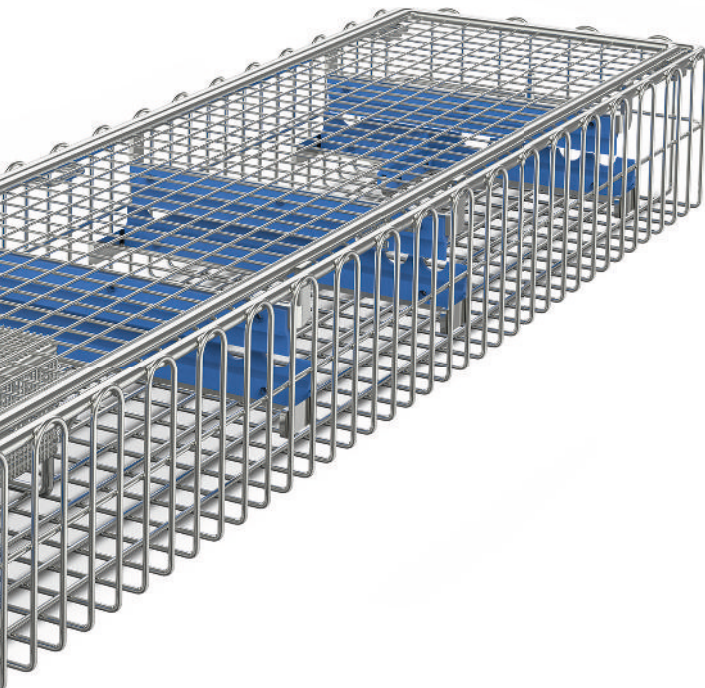

Special baskets for the packing area

In the packing area of a central sterilisation unit it is important that work is always carried out tidily and in the right order. Here, too, the sturdy, hygienic Hupfer wire baskets do their job reliably and provide perfect protection for the items inside.



Wire basket

- Mesh size: 8 × 8 mm
- With base frame

	Dimensions W × D × H mm	Product code
DraKo 100/100/100	100 × 100 × 100	7500900
DraKo 120/120/120	120 × 120 × 120	7500901
DraKo 140/140/140	140 × 140 × 140	7500902
DraKo 160/160/160	160 × 160 × 160	7500903
DraKo 180/180/180	180 × 180 × 180	7500904
DraKo 200/200/200	200 × 200 × 200	7500905
DraKo 300/200/200	300 × 200 × 200	7500906
DraKo 400/200/200	400 × 200 × 200	7500907



Used instruments basket

- Mesh size: 10 × 10 mm
- Welded mesh wire thickness: 1.2 mm
- For picking up contaminated instruments
- Electropolished stainless steel

	Dimensions W × D × H mm	Product code
SchmSi 245/175/100	244 × 177 × 100	7500075



Transport basket

- 400 × 300 × 200 mm
- Mesh size: 8 × 8 mm
- Electropolished stainless steel

	Dimensions W × D × H mm	Product code
TraKo 400/300/200	400 × 300 × 200	7500908



Containers



Polymer containers

Wherever wet or dripping materials have to be picked up in clinics or hospitals, Hupfer offers the right containers made of sturdy polymer or stainless steel for particularly tough applications. Equipped with lids, they ensure problem-free transport and a high level of hygienic safety.



Decontamination container

- With lid
- Temperature resistant from -20 °C to 80 °C
- Polypropylene
- Cannot be sterilised

	Dimensions W × D × H mm	Product code
BEH/Ents PP 600/300/200	590 × 290 × 192	7500882



Special container

- Resistant to disinfectant solutions, oils and grease
- Can briefly withstand 135 °C
- Cannot be sterilised
- Polypropylene

	Dimensions W × D × H mm	Product code
BEH/Spez 530/325/100	530 × 325 × 100	7500083
BEH/Spez 530/325/150	530 × 325 × 150	7500247
BEH/Spez 530/325/200	530 × 325 × 200	7500084



Transparent lid for special container

- Can briefly withstand 135 °C
- Resistant to: Disinfectants, oils, grease
- Polymer
- Cannot be sterilised

	Dimensions W × D × H mm	Product code
KlDeck 530/325	530 × 325 × 10	7500085



Containers



Stainless steel container

Our universal containers can handle almost any use or material. They are designed for uncompromisingly tough use. Robust and made of stainless steel, they can deal with jobs that containers made of other materials cannot do.



Universal stainless steel container

- External dimensions: 530 × 325 mm
- Material thickness: 0.8 mm
- Stainless steel

	Dimensions W × D × H mm	Product code
BGN 1/1-100	530 × 325 × 100	0130632H
BGN 1/1-150	530 × 325 × 150	0130642H
BGN 1/1-20	530 × 325 × 20	0130602H
BGN 1/1-200	530 × 325 × 200	0130652H
BGN 1/1-40	530 × 325 × 40	0130612H
BGN 1/1-55	530 × 325 × 55	0132792H
BGN 1/1-65	530 × 325 × 65	0130622H



Lid for universal stainless steel container

- Stainless steel

	Dimensions W × D × H mm	Product code
BGD 1/1	530 × 325	0131642H





Transport solutions

TRANSPORT
SOLUTIONS

02



Safe and efficient sterile supply cycles are crucial for successful work in clinics, hospitals and sterilisation facilities, hospitals and sterilisation plants. Hupfer offers integrated transport solutions tailored to the multiple, specific requirements and simple to handle as well as optimised user-friendliness.



Känguruh system



Integrated system for storage, transport and provision of sterile goods supplies

Depending on the location, the **push-in rack** is loaded with contaminated or sterile instruments. It has space for baskets and containers in StU or ISO format and keeps the instruments safe, from cleaning and sterilisation through to storage and distribution. A matching **platform** can also be used to store push-in racks, which among other things can be ideally integrated in the Hupfer Norm 5 shelving system.

The loaded **push-in rack** is pushed from the transport trolley into the sterilizer. After sterilisation, the push-in rack with the instruments can be moved directly onto the **transport trolley** and then safely taken to the storage location or to the operating theatre for further use – all without time-consuming repacking and hand contact.



Transfer via push through cupboard



Docking on to a transfer station

Advantages at a glance:

- Integrated system for storage, transport and provision of sterile goods
- No time-consuming repacking after cleaning, disinfection and functional testing
- Highest stainless steel quality for hardest use and maximum hygiene
- Excellent ergonomics and flexible handling
- All process steps without hand contact at the basket or container
- Optimisation of work efficiency and hygiene safety
- Transport trolleys, transport carts, platforms and push-in racks in many variants and special designs
- Also adaptable to driverless transport systems (DTS)

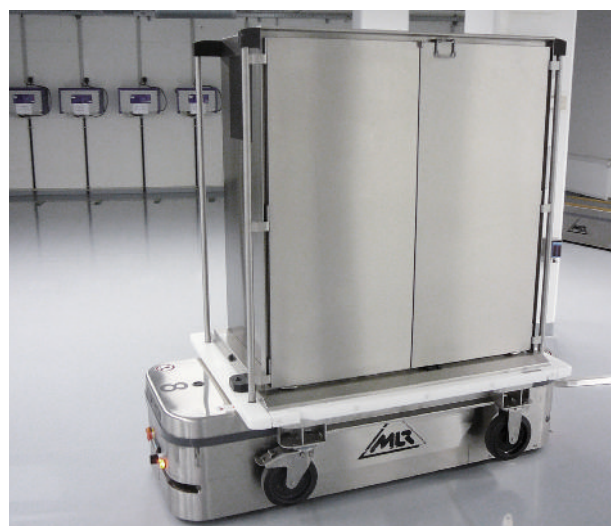

Driverless transport system with Känguruh system transport carts



External transport by lorry

Känguruh system



Custom planning and configuration

From planning through to configuration, the Känguruh system is adapted to the logistical requirements and the existing technical equipment. For example, in addition to the standard version, the transport carts are also available in fully-welded versions for maximum hygienic safety. The entire system can also be integrated into special in-house transport systems right up to driverless transport systems (DTS).

Intelligent solutions down to the finest detail

The Hupfer Känguruh system is based on many years of experience in sterile supplies logistics and the latest design and manufacturing expertise. Its unique functionality and the high quality of materials and workmanship are not only reflected in the overall concept, but also in many practical details designed for efficient and ergonomic operation.



Lengthwise and/or transverse docking are available optionally.



L-shape or U-shape profile rails for optimum matching to StU baskets and containers as well as ISO baskets.



With the optional 3 or 4-sided gallery rail, the top of the trolley can also be used for storage and transport.



Transport cart can be easily labelled with the optional paper clamp. Sign holders in various formats are available on request.



The transport cart is also available as a universal transport cart (ATW) for transporting a wide variety of goods.



The optional central lock allows fixing in position with just one foot movement.



Wired shelves and perforated plates for placing on L-shape profile rails allow a wide variety of goods and containers to be stored. Optional pull-out frame sets make work even easier.



For transport by truck, the wagons are available with special lorry transportation protection on request.



The optional transport latch with sealing option provides maximum security for the sterile supplies.



The optional sign holders provide the clearest possible overview.

Känguruh system

Känguruh system



Transport carts

- Modular construction
- Various castor versions and equipment
- Traction operation with coupling/drawbar (also friction-damped)
- Stainless steel



	StU	ISO	Dimensions W × D × H mm	Product code
KÄ-TW/M 6StE 965/751/1468 SH260	6		965 × 751 × 1468	7504659
KÄ-TW/M 9StE 1285/751/1471 SH 260	9	6	1472 × 751 × 1294	7504660



Fully-welded transport cart

- Fully-welded construction suitable for washing devices
- Various castor versions and equipment
- Traction operation with coupling/drawbar (also friction-damped)
- Stainless steel



	StU	ISO	Dimensions W × D × H mm	Product code
KÄ-TW/VV 3StE 724/754/1444 SH260	3	3	754 × 724 × 1444	7505986
KÄ-TW/VV 6StE 965/754/1444 SH260	6		1444 × 980 × 765	7504617
KÄ-TW/VV 9StE 1249/754/1434 SH260	9	6	1439 × 1284 × 754	7504624



Känguruh push-in rack with L-shape profile rails

- With L-shape profile rails
- For holding StU and ISO baskets or containers
- Stainless steel



	StU	Dimensions W × D × H mm	Product code
KÄ-EG 3StE 355/615/1041 L-Sch	3	615 × 355 × 1041	7504595
KÄ-EG 6StE 685/615/1041 L-Sch	6	685 × 615 × 1041	7504622
KÄ-EG 9StE 1015/615/1041 L-Sch	9	1015 × 615 × 1041	7504626



Känguruh push-in rack with U-shape profile rails

- Medidul U-shape profile rail
- For holding StU and ISO baskets or containers
- Stainless steel

	ISO	Dimensions W × D × H mm	Product code
KÄ-EG ISO 455/615/1041 8U-Sch	3	615 × 455 × 1041	7504649
KÄ-EG ISO 885/615/1041 16U-Sch	6	885 × 615 × 1041	7504650



Push-in rack with wired shelf

- with wire shelves
- For holding StU and ISO baskets or containers
- Stainless steel

	StU	Dimensions W × D × H mm	Product code
KÄ-EG 6StE 685/615/1041 3 DR	6	685 × 615 × 1041	7504620
KÄ-EG 9StE 1015/615/1041 3 DR	9	1015 × 615 × 1041	7504625



Känguruh transfer trolley

- Secure locking on the transport cart
- Secure locking of the push-in rack
- Optional design compatible with sterilisation and washing devices

	StU	ISO	Dimensions W × D × H mm	Product code
KÄ-ÜW 1ISO 717/560/909 SH260		3	909 × 560 × 770	7504651
KÄ-ÜW 3StE 717/425/909 SH260	3		909 × 425 × 770	7504618
KÄ-ÜW 6StE 854/677/909 SH260	6		854 × 677 × 909	7504621
KÄ-ÜW 9StE/2ISO 1137/677/909 SH260	9	2	1137 × 677 × 909	7504627

Känguruh System



Känguruh platform

- Stainless steel
- For parking and storing the push-in rack
- Base cladding on request



	StU	ISO	Dimensions W × D × H mm	Product code
KÄ-UG 6StE 850/700/307 SH260	6		850 × 700 × 307	7504619
KÄ-UG 9StE 1130/700/307 SH260	9	2	1130 × 700 × 307	7504628



Känguruh transfer station

- Stainless steel



	Product code
KÄ-ÜGS	7504716



Container and sterile goods transport carts



Transport carts are an integral part of the supply and disposal of sterile supplies. They ensure hygienically safe transport through unclean areas as well as safe transport of used supplies to be disposed of. They can also be used flexibly for keeping goods in storage.

The transport carts are available in two versions: a cost-optimised modular version and a version with a fully-welded housing for maximum hygienic safety.



State of the art: fully-welded stainless steel housing

The stable, self-supporting and hygienically fully-welded stainless steel housing has no undercuts and thus offers optimal prerequisites for the highest hygiene and easy to clean. Due to the fully-welded housing the transport carts are washing plant suitable.



Cost-optimized: Modular construction in stainless steel

The modular version made of high-quality stainless steel is the ideal combination of proven loading capacity and cost-optimised design. This makes them a reliable and versatile asset.

Container and sterile goods transport carts

Transport carts

Wherever containers, baskets or sterile supplies have to be protected when transported or stored, enclosed transport carts are the ideal solution. Their sturdy construction, practical equipment and easy manoeuvring make them reliable companions for daily use.



Container transport carts

- With L-shape profile rail for StU
- With U-shape profile rail for ISO
- Vertical push handles
- Wing doors with 270° opening angle
- Circumferential door seals



	Compartment design	StU	ISO	Dimensions W × D × H mm	Product code
CTW/M 3ISO 785/751/1471	modular		3	785 × 751 × 1471	7505987
CTW/M 3StE 785/751/1471	modular	3		785 × 751 × 1471	7505989
CTW/M 6ISO 1285/751/1471	modular		6	1285 × 751 × 1471	7505988
CTW/M 6StE 965/751/1469	modular	6		965 × 751 × 1469	7504643
CTW/M 9StE 1249/751/1469	modular	9		1249 × 751 × 1469	7504644



Full-welded container transport cart

- With L-shape profile rail for StU
- Vertical push handles
- Wing doors with 270° opening angle
- Circumferential door seals



	Compartment design	StU	Dimensions W × D × H mm	Product code
CTW/VV 3StE 724/754/1445	fully-welded	3	754 × 724 × 1445	7505985
CTW/VV 6StE 965/754/1445	fully-welded	6	1445 × 1000 × 754	7504641
CTW/VV 9StE 1249/754/1440	fully-welded	9	1440 × 1284 × 754	7504642



Sterile goods transport cart with wired shelf

- Vertical push handles
- Wing doors with 270° opening angle
- Circumferential door seals



	Compartment design	StU	Dimensions W × D × H mm	Product code
STW/M 6StE 985/751/1471	modular	6	985 × 751 × 1472	7504647
STW/M 9StE 1285/751/1471	modular	9	1285 × 751 × 1472	7504648



Sterile goods transport cart with solid shelves

- Vertical push handles
- Wing doors with 270° opening angle
- Circumferential door seals

	Compartment design	StU	Dimensions W × D × H mm	Product code
STW/VV 3StE 724/754/1445	fully-welded	3	754 × 724 × 1445	7505984
STW/VV 6StE 965/754/1464	fully-welded	6	1464 × 1000 × 754	7504645
STW/VV 9StE 1249/754/1464	fully-welded	9	1464 × 1269 × 754	7504646



Case cart for sterile goods

- Vertical push handles
- 270° wing doors
- Stainless steel
- Circumferential door seals
- Usable internal dimension W × D × H mm: 545 × 650 × 635 mm



	Compartment design	Dimensions W × D × H mm	Product code
STW/S-US-1S 841/769/1000	modular	841 × 769 × 1000	7505990
STW/S-US-1T 785/751/1471	modular	785 × 751 × 1471	7505992
STW/S-US-2S 1341/769/1000	modular	1341 × 769 × 1000	7505991

Container and sterile goods transport carts



Transport trolleys

This versatile equipment for intermediate storage or transport is ideal for a wide range of applications and working areas. Our open transport carts are available in various designs and keep containers, baskets and working materials clearly and visibly available at all times. The high-quality stainless steel design makes them extremely load-bearing and durable.



Container transport trolley

- With L-shape profile rails
- With welded cover on top
- Antistatic castors
- Stainless steel
- Safe driving



	StU	SPRI	ISO	Dimensions W × D × H mm	Product code
CTW/O 10SPRI 1036/750/1400 SF		10		1036 × 750 × 1400	7505575
CTW/O 3ISO 595/395/215			3	670 × 525 × 1141	7504971
CTW/O 3StE 425/670/1145	3			670 × 425 × 1145	7505523
CTW/O 4StE 791/635/1029	4			791 × 635 × 1029	7505694
CTW/O 4StE/4ISO 855/670/1739	4		4	1739 × 670 × 938	7593519
CTW/O 6ISO 955/670/1144			6	955 × 670 × 1144	7504970
CTW/O 6StE 686/634/950	6			686 × 634 × 950	7504177
CTW/O 6StE 755/670/1368	6			755 × 670 × 1368	7504225
CTW/O 9StE 1085/670/1368	9			1085 × 670 × 1368	7504211



Sterile goods transport trolley

- 2 fixed and 2 variable shelves
- Antistatic castors
- Stainless steel

	StU	Dimensions W × D × H mm	Product code
STW/O 6StE 755/670/1370	6	755 × 670 × 1370	7504228
STW/O 9StE 1070/670/1370	9	1070 × 670 × 1370	7504212



ISO trolley

- For 12 ISO baskets
- For pushing into each other
- Pitch: 110 mm

	Dimensions W × D × H mm	Product code
RWG/E 1/12ISO 110-L-U 001	738 × 525 × 1686	7506153



Container and sterile goods transport carts

Accessories for container and sterile goods transport carts



Gallery rail

- Stainless steel

	Gallery	Product code
GA/3-s TW9	three-sided	7504232
GA/4-s TW9	four-sided	7504233



Paper clamp for transport cart

- For factory assembly
- Bolt fixing
- Stainless steel

	Dimensions W × D × H mm	Product code
PapKL 90/18/70	90 × 18 × 70	7500895



Clipboard

- Robust
- Secure holding of the documents
- Easy writing
- Convenient browsing
- Easy hanging

	Dimensions W × D × H mm	Product code
KB 350/220/33 A4 mPK	350 × 220 × 33	7505695



Profile rail with 2 hooks

- Effective length of hooks: 150mm
- Electropolished stainless steel
- Attachment and removal without tools
- Clear storage of the sterile goods
- Maximum hygiene



	Dimensions W × D × H mm	Product code
ANH-LEI 594/40/80	594 × 40 × 80	7504357



Transport security

- For CTW/O
- Pivoting
- 51 × 91 × 1050 mm



	Dimensions W × D × H mm	Product code
TS CTW/O	1050 × 91 × 51	7500762



Push handle

- For CTW/O & STW/O
- Assembly height 900 mm above floor



	Dimensions W × D × H mm	Product code
SG/CTW/O - STW/O	600 × 88 × 85	7500362

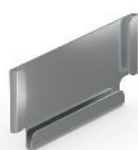

Card holder

- Optimised logistics
- Reliable mounting
- Maximum hygiene



	Dimensions W × D × H mm	Product code
SH 117/50/5	117 × 50 × 5	7504379
SH 320/254/5	320 × 254 × 5	7504381

Container and sterile goods transport carts



Card holder DIN A5

- For transportation carts
- Optimised logistics
- Reliable mounting
- Maximum hygiene



	Dimensions W × D × H mm	Product code
SH 241/153/12 DIN A5	241 × 153 × 12	7504380



Wired shelf

- For STW-6
- High-quality Electropolished stainless steel
- Ventilated shelf
- Easy to hook in
- Optimum hygiene



	Dimensions W × D × H mm	Product code
A-DR 980/540/43	980 × 540 × 43	7505111



Solid shelf

- For STW/O & STW/VV
- Easy to clean
- Perfect hygiene
- High weight capacity
- Easy handling



	Product code
A-GS 685/550/40	7501758
A-GS 980/550/40	7501759

Universal transport cart

Wherever containers, baskets or sterile supplies have to be protected when transported or stored, enclosed transport carts are the ideal solution. Their sturdy construction, practical equipment and easy manoeuvring make them reliable companions for daily use.



Universal transport cart

- Vertical push handles
- Circumferential door seals
- Stainless steel
- 270° wing doors



	Compartment design	StU	Dimensions W × D × H mm	Product code
STW/M 6StE 965/751/1469 DR	modular	6	965 × 751 × 1469	7504844
STW/M 9StE 1249/751/1469 DR	modular	9	1249 × 751 × 1469	7504845



Fully-welded universal transport cart

- With folding louvred shelf
- Stainless steel



	Gallery	Dimensions W × D × H mm	Product code
ATW/VV 6StE 965/754/1487	four-sided	965 × 754 × 1487	7504807
ATW/VV 9StE 1249/754/1464	four-sided	1249 × 754 × 1464	7504806

Hook System



Hook System

Hupfer hook trolleys provide clearly organised, instant access to many different items and are perfect for transport, intermediate storage and use. Constructed entirely of stainless steel tubes, they can be adapted to the requirements at hand with a variety of equipment options and attachments.



Hook system

Hook system



Hook trolley set for invasive surgery

- Set consisting of 6 sterile goods baskets, 6 storage bins, 1 hanging rail with 6 hooks, 1 shelf and 1 wire holder for disposable gloves.
- Suitable for invasive surgery
- Maximum load per hook 30 kg



HAW 1000/605/1907 InvOP

Product code

7506473



Hook trolley set for urology

- Set consisting of 9 sterile goods baskets, 1 sterile goods tray, 1 wire container, 2 catheter baskets, 3 polymerc containers, 1 wire holder for disposable gloves and accessories for fastening
- Suitable for urology



HAW 650/1005/1657 Uro

Product code

7506474



Hook trolley set for anaesthesia

- Set consisting of 8 sterile goods baskets, 4 storage bins, 1 catheter basket and accessories for fastening
- Suitable for anaesthesia



HAW 605/675/1620 Anä

Product code

7506475



HAW 605/675/1620 Vis

Hook trolley for visceral surgery

- Set consisting of 5 sterile goods baskets, 1 inclined element for sterile goods basket, 1 suture storage unit and 1 storage board
- Suitable for visceral surgery



Product code

7506476



HAW 650/1005/1657 Orth

Hook trolley set for orthopaedics

- Set consisting of 5 sterile goods baskets and 1 insertion frame set for 4 StU.
- Suitable for orthopaedics



Product code

7506477



HAW 605/620/1620 StE

Hook trolley set for StU containers

- Set consisting of 4 holders for StU sterile goods containers
- Universally applicable



Product code

7506478



HAW 605/620/1620 1/4HP 4K0

Hook trolley set for 20 pairs of shoes

- Set consisting of 4 baskets for surgical shoes



Product code

7506173

Hook system



Hook trolley set for 40 pairs of shoes

- Set consisting of 8 baskets for surgical shoes
- Maximum load per hook 30 kg

HAW 605/675/1620 2/8HP 8Ko	Product code	
	7506174	



Theatre shoe rack

- Hook trolley set for 20 pairs of shoes
- Efficient and ergonomic logistics solution
- Hygienic and high quality

OP-SchReg 955/620/1733	Dimensions W × D × H mm	Product code
	955 × 620 × 1733	7523344



Theatre step trolley

- Robust stainless steel construction
- Three brackets in the lower part
- Antistatic castors
- Upper part with two pairs of hooks on both sides
- Ø castors 75 mm

HAW 720/675/1800 2/4HP + Aufl	Hook pairs	Dimensions W × D × H mm	Product code
	4	720 × 675 × 1800	7505735



Suture trolley

- Sturdy aluminium frame with three solid stainless steel panels
- Two perspex wing doors
- All-round impact protection even when doors are fully open
- Hook frame with 40 mm pitch
- Ø castors 125 mm

NMW/G 837/576/1720	Hook pairs	Dimensions W × D × H mm	Product code
	4	837 × 576 × 1720	7505730



Hook trolley with single side loading

- Maximum load per hook 30 kg
- Disc bumpers
- Ø castors 100 mm

	Hook pairs	Max. load per hook kg	Dimensions W × D × H mm	Product code
HAW 605/465/1097 1/2HP	2	30	605 × 465 × 1097	7500472
HAW 605/465/1460 1/3HP	3	30	605 × 465 × 1460	7500032
HAW 605/620/1620 1/4HP	4	30	620 × 605 × 1620	7500092



Hook trolley with double side loading

- Maximum load per hook 30 kg
- Disc bumpers
- Ø castors 100 mm

	Hook pairs	Max. load per hook kg	Dimensions W × D × H mm	Product code
HAW 605/675/1097 2/4HP	4		675 × 605 × 1097	7500465
HAW 605/675/1460 2/6HP	6	30	675 × 605 × 1460	7500033
HAW 605/675/1620 2/8HP	8	30	675 × 605 × 1620	7500093
HAW 605/675/1681 2/8HP 001	8		675 × 605 × 1681	7506129



Hook trolley with triple side loading

- Maximum load per hook 30 kg
- Disc bumpers
- Ø castors mm 100

	Hook pairs	Dimensions W × D × H mm	Product code
HAW 1000/605/1907 3/15HP	15	1000 × 605 × 1907	7500870

Hook system



Hook trolley Medidul

- Maximum load per hook 30 kg
- Disk bumpers
- Ø castors mm 100



	Hook pairs	Dimensions W × D × H mm	Product code
HAW 650/1005/1657 2/4HP Medidul	8	1005 × 650 × 1657	7500801



L-shape profile rail for hook trolley Medidul

- Package content: 1 pair
- Bearing face 60 mm
- Stainless steel



	Insertions	Dimensions W × D × H mm	Product code
RG-ESS/L MEDIDUL 594/84/39	L-shape profile rails	594 × 84 × 39	7504213



U-shape profile rail for hook trolley Medidul

- Package content: 1 pair
- Bearing face 14 mm
- Stainless steel



	Insertions	Product code
RG-ESS/U MEDIDUL 36/570/41	U-shape profile rails	7505009



Pull-out frame set for hook trolley Medidul

- Appr. 3/4 extension
- Stainless steel
- For StU containers and baskets
- For ISO containers and baskets



	Dimensions W × D × H mm	Product code
ERS ISO 448/595/66	595 × 448 × 66	7501216
ERS StE 296/595/60	595 × 296 × 60	7504555



Insert shelf

- Perforated
- For placing on L-shaped rails
- Stainless steel



	Dimensions W × D × H mm	Product code
EiBl 300/600/15 gel	600 × 300 × 15	7504373



Wall-mounted hook rails

- Welded hooks
- 30 kg maximum load per hook
- Threaded bolt for equipotential bonding
- Tube ends closed with plastic caps



	Dimensions W × D × H mm	Product code
WHSc 1050-3/350	43 × 40 × 1050	7500028
WHSc 1300-3/410	43 × 40 × 1300	7500187
WHSc 1300-6/215	43 × 40 × 1300	7500190
WHSc 1400-4/350	43 × 40 × 1400	7500029
WHSc 1600-4/410	43 × 40 × 1600	7500188
WHSc 1600-7/215	43 × 40 × 1600	7500031
WHSc 1750-5/350	43 × 40 × 1750	7500030
WHSc 700-2/350	43 × 40 × 700	7500027
WHSc 900-2/410	43 × 40 × 900	7500186
WHSc 900-4/215	43 × 40 × 900	7500189

Attachments



Attachment for hook system

The great variety of available attachments means that the hook trolleys can be adapted to many different functions and tasks. They are all characterised by excellent workmanship, durability, functionality and ergonomics for safe and efficient work processes.



Shoe basket

- Up to 5 pairs of shoes
- Electropolished stainless steel



	Dimensions W × D × H mm	Product code
SchuKo 585/300/320	585 × 300 × 320	7501457



Wire holder for theatre-clogs

- Up to 6 pairs of shoes
- Closed wire loops
- Electropolished stainless steel



	Dimensions W × D × H mm	Product code
H-D 600/263/191	600 × 263 × 191	7500452



Shoe rack

- Up to 6 pairs of shoes
- Electropolished stainless steel



	Dimensions W × D × H mm	Product code
SchReg 600/320/270	600 × 320 × 234	7500374



Wire holder for sterilisation rolls

- For foil rolls of different widths
- Electropolished stainless steel



	Dimensions W × D × H mm	Product code
H-D 630/270/194	630 × 270 × 194	7500552



Paper holder

- Electropolished stainless steel
- 3 levels



	Dimensions W × D × H mm	Product code
PapHa 1250/240/200	1250 × 240 × 200	7500663

Attachments



Sterilisation roll cutter

- Holder for storing, cutting and dispensing sterile packaging in the form of foil rolls
- Complete cut of the tubular foil, even when fully loaded
- Electropolished stainless steel



	Cutting width	Dimensions W × D × H mm	Product code
RHT SB114	1140 mm	1253 × 373 × 294	7507011
RHT SB139	1390 mm	1510 × 373 × 294	7507009
RHT SB51	510 mm	623 × 373 × 294	7507012
RHT SB79	790 mm	903 × 373 × 294	7507010



Wire holder for urine bottles

- Up to 4 urine bottles
- Electropolished stainless steel



	Dimensions W × D × H mm	Product code
H-D 560/248/272	560 × 248 × 272	7500106

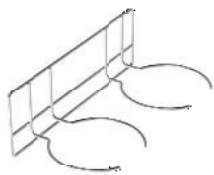

Wire holder for stack wells

- Up to 2 stack wells
- Each stack well holder is 245 mm in diameter
- Electropolished stainless steel



	Dimensions W × D × H mm	Product code
H-D 560/280/180	560 × 281 × 180	7500104



Wire holder for disposable gloves

- Up to 6 disposable glove boxes
- Effective dimensions: 180 × 54 mm (per compartment)
- Electropolished stainless steel

	Dimensions W × D × H mm	Product code
H-D 555/139/215	555 × 139 × 215	7500384



Glove dispenser

- 3 compartments for different gloves
- Stainless steel

	Dimensions W × D × H mm	Product code
HaSp 580/327/271	580 × 327 × 271	7500080



Wire holder with hooks

- Effective length of hooks: 150mm
- Electropolished stainless steel
- Attachment and removal without tools
- Clear storage of the sterile goods
- Maximum hygiene

	Hook pairs	Dimensions W × D × H mm	Product code
ANH-LEI 555/182/82	4	555 × 182 × 82	7500451
ANH-LEI 636/186/71	3	636 × 186 × 71	7500871



Wire holder for endoscopes

- Effective length of hooks: 150 mm
- Electropolished stainless steel
- Attachment and removal without tools
- Clear storage of the sterile goods
- Maximum hygiene

	Hook pairs	Dimensions W × D × H mm	Product code
ANH-LEI 555/164/82	7	555 × 163 × 122	7501927

Attachments



Sterile goods shelf

- Welded wire loops
- Electropolished stainless steel

	Dimensions W × D × H mm	Product code
SteriAbl 555/315/170	553 × 314 × 170	7500440



Wire holder for StU containers

- Electropolished stainless steel

	Dimensions W × D × H mm	Product code
H-D 612/316/300	612 × 316 × 300	7500373



Wire holder for tubes and cables

- 11 closed wire loops
- Electropolished stainless steel

	Dimensions W × D × H mm	Product code
H-D 600/113/181	600 × 113 × 181	7500460



Paper holder

- For paper sheets for sterile packaging
- Electropolished stainless steel

	Dimensions W × D × H mm	Product code
PapAbl 560/284/303	560 × 284 × 303	7500478



Shelf

- For notebook or computer monitor
- Electropolished stainless steel



	Dimensions W × D × H mm	Product code
AblBo 575/390/155	575 × 390 × 155	7500467



Writing desk

- With inclined writing surface and upstand in the front
- Stainless steel



	Dimensions W × D × H mm	Product code
SP 580/340/225	580 × 340 × 225	7500097



Suture storage unit

- For storage and provision of suture material in 10 standard small packages
- Stainless steel



	Dimensions W × D × H mm	Product code
NaAbl 600/170/152	600 × 170 × 152	7500170
NaAbl 600/170/290	600 × 170 × 290	7500079
NaAbl 604/135/181	604 × 140 × 187	7500450
NaAbl 604/135/365	604 × 138 × 371	7500458

Attachments



Universal shelf

- With rear wall and upstands on the sides
- For universal use
- Shelf dimensions: 596 × 357 mm
- Stainless steel



	Dimensions W × D × H mm	Product code
UniAbl 600/360/260	600 × 360 × 260	7500086
UniAblBo 695/350/165	695 × 350 × 165	7502154



Universal holder for containers

- For wire containers
- For size 3, 4 and 5 storage bins
- Stainless steel



	Dimensions W × D × H mm	Product code
UniHalt 655/20/109	655 × 20 × 109	7500448
UniHalt 690/20/329	690 × 20 × 329	7500848



Wire container

- For transport, storage and provision of small parts for medical use
- For hanging in universal holder
- Electropolished stainless steel



	Dimensions W × D × H mm	Product code
DCont G3 215/350/200	350 × 215 × 200	7502945
DCont G4 153/231/125	231 × 153 × 125	7502946



Blue polymer storage bin

- For hanging in universal holder
- Temperature resistant from -40 °C to 80 °C
- Polyethylene

	Dimensions W × D × H mm	Product code
KCont G3 210/350/200 bl	350 × 210 × 200	7502743
KCont G4 150/230/125 bl	230 × 150 × 125	7502753
KCont G5 100/170/75 bl	170 × 100 × 75	7502763



Green polymer storage bin

- For hanging in universal holder
- Temperature resistant from -40 °C to 80 °C
- Polyethylene

	Dimensions W × D × H mm	Product code
KCont G3 210/350/200 gn	350 × 210 × 200	7502746
KCont G4 150/230/125 gn	230 × 150 × 125	7502756
KCont G5 100/170/75 gn	170 × 100 × 75	7502766



Holder for laundry/waste bags

- For 1 laundry or waste bag 60–70 l
- Electropolished stainless steel

	Dimensions W × D × H mm	Product code
H-B 555/313/240	555 × 313 × 240	7500101



Attachments



Double shelf unit

- Shelf dimensions: 540 × 190 mm
- Shelf spacing: 190 mm
- Sheet thickness: 1.0 mm
- Stainless steel



	Dimensions W × D × H mm	Product code
AblBoDo 560/200/305	560 × 200 × 305	7500636



Wire container for medical equipment rails

- Electropolished stainless steel



	Dimensions W × D × H mm	Product code
DCont fGS G3 350/210/200	350 × 210 × 200	7502948
DCont fGS G4 230/150/125	288 × 152 × 125	7502947



Catheter basket for medical equipment rails

- Mesh size: 8 × 8 mm
- Electropolished stainless steel
- For hanging in universal holder



	Dimensions W × D × H mm	Product code
KaKo 150/100/200 MW 8/8	150 × 100 × 200	7500150
KaKo 150/100/280 MW 8/8	150 × 100 × 280	7500151
KaKo 150/100/480 MW 8/8	150 × 100 × 480	7500152



Angled support for StU basket

- For ergonomic inclination of suspended sterile goods baskets
- For hanging on wall-mounted hook rails
- Package content: 2 units
- Stainless steel



	Dimensions W × D × H mm	Product code
SchrElem 35/62/111	62 × 35 × 111	7500289



Wire holder for polymer StU container and its lid

- For containers and bins in StU format
- With shelf for a lid
- Electropolished stainless steel



	Dimensions W × D × H mm	Product code
H-D 622/311/272	622 × 311 × 272	7500896



Wire holder for StU container

- Secure, open storage
- High-quality Electropolished stainless steel
- Effortless hooking in and removal
- optimum hygiene



	Product code
H-D 622×316×58	7500375



Wire holder for special container

- Max. 1 special container 530 × 325 mm with lid
- Electropolished stainless steel



	Dimensions W × D × H mm	Product code
H-D 556/317/130	556 × 317 × 130	7500222

Attachments



Sheet metal holder for special container

- For special containers 530 × 325 mm with lid
- Stainless steel

	Dimensions W × D × H mm	Product code
H-B 560/325/305	560 × 325 × 305	7500095



Wired shelf

- Open to the front for quickest access
- Electropolished stainless steel

	Dimensions W × D × H mm	Product code
DrAbl 1480/285/150	285 × 155 × 1480	7500597
DrAbl 1480/395/150	1480 × 395 × 150	7500593



Shelf basket

- Access-friendly engagement slope
- Can be divided with wire basket dividers
- Electropolished stainless steel

	Dimensions W × D × H mm	Product code
ANH-KO 575/285/150	575 × 285 × 150	7500592
ANH-KO 575/395/150	575 × 395 × 150	7500596



Separating grid for shelf baskets

- Optimum use of the storage space
- quick adjustment
- Effortless hooking in and removal
- optimum hygiene



	Dimensions W × D × H mm	Product code
TG 258/125/10	258 × 125 × 10	7500594
TG 368/125/10	368 × 125 × 10	7500595

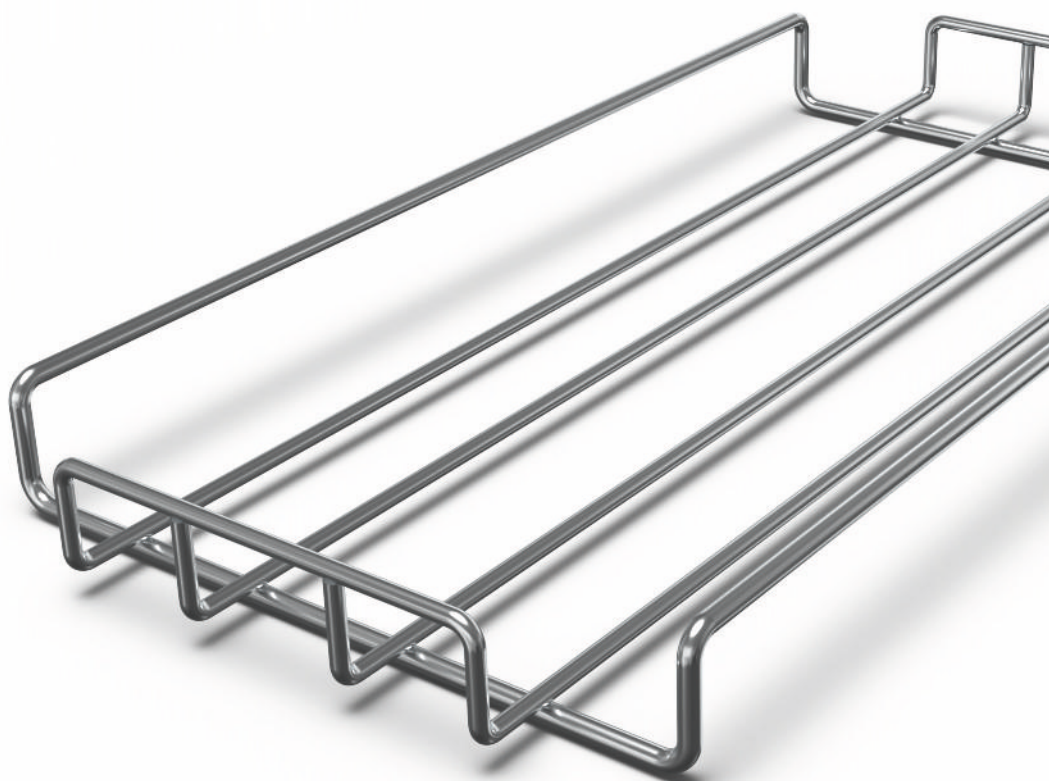

Transport trolleys

Hupfer transport trolleys

Hupfer offers a range of transport trolleys for many different functions and uses. The range includes all-rounders for a wide variety of tasks as well as special designs for use in and around the operating theatre.

Dedicated workmanship, high-quality materials and practical design guarantee reliability and durability. With robust, smooth-running castors, ergonomic design, easy cleaning and proven functionality, they ensure smooth workflows in everyday hospital life.





Mobile general purpose table

The name says it all: Hupfer general purpose trolleys are sturdy, flexible and manoeuvrable, making them ideal for a wide range of clinical tasks. They are suitable for transport, intermediate and long-term storage, and much more.



Mobile general purpose table

- 2 flat, welded shelves
- Antistatic castors
- Height of top shelf: 800 mm



	Dimensions W × D × H mm	Product code
AZW 625/425/800	625 × 425 × 800	7500468
AZW 720/625/800	720 × 625 × 800	7500470
AZW 920/625/800	920 × 625 × 800	7500469
AZW 1200/625/800	1263 × 689 × 800	7500661

Transport trolleys

Medical general purpose trolley

These robust helpers can be used in a variety of ways for transporting and temporarily storing equipment and working materials. The medical multi-purpose trolleys are also available with a push handle on one side as an alternative to the standard version.



Medical general purpose trolley with two shelves

- Antistatic castors
- 2 shelves
- Payload: 80 kg
- Shelf clearance: 538 mm



	Shelves	Dimensions W × D × H mm	Product code
MSW 6x4/2	2	695 × 495 × 900	7504128
MSW 8x5/2	2	895 × 595 × 950	7504001
MSW 10x6/2	2	1095 × 695 × 950	7504002



Medical general purpose trolley with three shelves

- Antistatic castors
- 3 shelves
- Payload: 120 kg
- Shelf clearance: 251 mm



	Shelves	Dimensions W × D × H mm	Product code
MSW 6x4/3	3	695 × 495 × 900	7504129
MSW 8x5/3	3	895 × 595 × 950	7504005
MSW 10x6/3	3	1095 × 695 × 950	7504006



Medical general purpose trolley with four shelves

- Antistatic castors
- 4 shelves
- Payload: 150 kg
- Shelf clearance: 278 mm



	Shelves	Dimensions W × D × H mm	Product code
MSW 8x5/4	4	895 × 595 × 1265	7504009



Heavy-duty medical general purpose trolleys

All-rounder with extra-high payload for extra-heavy transport tasks in special work situations.



Heavy-duty medical general purpose trolley with two shelves

- Antistatic castors
- Payload: 120 kg
- Shelf clearance: 591 mm
- Stainless steel



	Shelves	Dimensions W × D × H mm	Product code
MSSW 8x5/2	2	895 × 595 × 1015	7504107
MSSW 10x6/2	2	1095 × 695 × 1015	7504110



Heavy-duty medical general purpose trolley with three shelves

- Antistatic castors
- Payload: 180 kg
- Shelf clearance: 278 mm
- Stainless steel



	Shelves	Dimensions W × D × H mm	Product code
MSSW 8x5/3	3	895 × 595 × 1015	7504113
MSSW 10x6/3	3	1095 × 695 × 1015	7504114

Transport trolleys



Heavy-duty medical general purpose trolley with four shelves

- Antistatic castors
- Payload: 200 kg
- Shelf clearance: 278 mm
- Stainless steel



	Shelves	Dimensions W × D × H mm	Product code
MSSW 10x6/4	4	1095 × 695 × 1325	7504120





Ergonomic general purpose trolleys

The push bar is designed according to the latest ergonomic principles and makes work easier for staff, protecting them from strain.



Ergonomic general purpose trolley with two shelves

- With ergonomic handle
- Payload: 120 kg
- Shelf clearance: 591 mm
- Stainless steel



	Shelves	Dimensions W × D × H mm	Product code
SW 8x5/2 ERGO	2	1035 × 595 × 1270	0133703
SW 10x6/2 ERGO	2	1235 × 695 × 1270	0133723



Ergonomic general purpose trolley with three shelves

- With ergonomic handle
- Payload: 140 kg
- Shelf clearance: 278 mm
- Stainless steel



	Shelves	Dimensions W × D × H mm	Product code
SW 8x5/3 ERGO	3	1035 × 595 × 1270	0133713
SW 10x6/3 ERGO	3	1235 × 695 × 1270	0133733

Transport trolleys



Enclosed general purpose trolley

In addition to all the advantages of the Hupfer general purpose trolleys, the enclosed version offers more safety during transport and easy access at the same time.



Enclosed general purpose trolley with two shelves

- With wing doors
- Payload: 80 kg
- Shelf clearance: 591 mm
- Stainless steel



	Shelves	Dimensions W × D × H mm	Product code
GSW 8x5/2	2	900 × 600 × 950	0111934
GSW 10x6/2	2	1100 × 700 × 950	0112054



Enclosed general purpose trolley with three shelves

- With wing doors
- Payload: 120 kg
- Shelf clearance: 278 mm
- Stainless steel



	Shelves	Dimensions W × D × H mm	Product code
GSW 8x5/3	3	900 × 600 × 950	0111964
GSW 10x6/3	3	1100 × 700 × 950	0112084

Accessories for general purpose trolleys

Accessories for general purpose trolleys



Three-sided gallery rail

- Gallery height: 50 mm
- Stainless steel

	Dimensions W × D × H mm	Product code
GA/3-s SW6x4 Ø8/599/330/50	599 × 330 × 50	0114506
GA/3-s SW8x5 Ø8/799/430/50	799 × 430 × 50	0114502
GA/3-s SW10x6 Ø8/999/530/50	999 × 530 × 50	0114503



Four-sided gallery rail

- Gallery height: 50 mm
- Stainless steel

	Dimensions W × D × H mm	Product code
GA/4-s SW6x4 Ø8/599/399/50	599 × 399 × 50	0114507
GA/4-s SW10x6 Ø8/999/599/50	999 × 599 × 50	0114505
GA/4-s SW8x5 Ø8/799/499/50	799 × 50 × 499	0114504



Hook-on container

- 420 × 200 × 250 mm
- With hooks
- Stainless steel

	Dimensions W × D × H mm	Product code
ANH-BEH 420/200/250 SW	420 × 200 × 250	0116192

Accessories for general purpose trolleys



Waste bag holder

- With rubber seal
- Stainless steel

	Dimensions W × D × H mm	Product code
MHR 120 350/283/736	350 × 283 × 736	0114802



Reinforcing bar

- Fully-welded
- Stainless steel

	Dimensions W × D × H mm	Product code
VUZ SW 6x4	575 × 397 × 29	0114584
VUZ SW 8x5	775 × 497 × 29	0114582
VUZ SW 10x6	975 × 597 × 29	0114583

Special transport trolleys



Operation theatre equipment trolleys

This range for use in and around the operating theatre is tailored to the particularly stringent requirements for this area. High-quality materials and workmanship down to the last detail guarantee maximum safety, reliability and hygiene.



Operating theatre provisioning table

- Plate size: 665 × 665 mm
- 2 hook-on insert rail pairs
- One welded rail pair
- Antistatic castors
- Stainless steel



	Dimensions W × D × H mm	Product code
SBT 700/700/900 F	700 × 700 × 900	7500752



Operating theatre instrument table

- 625 × 425 × 800 mm
- With removable tabletops
- Frame acts as gallery rail
- Antistatic castors



	Dimensions W × D × H mm	Product code
IT 625/425/800 F	625 × 425 × 800	7500204
IT 720/625/800 F	720 × 625 × 800	7500205
IT 1050/550/880 F	1054 × 554 × 880	7505708
IT 625/425/650 F	625 × 425 × 650	7500704
IT 1200/550/920 F	1204 × 554 × 920	7505707
IT 900/550/840 F	904 × 554 × 840	7505709
IT 940/625/800 F	964 × 649 × 800	7500206

Special transport trolleys



Operating theatre instrument stand

- Height adjustable from 715–1200 mm
- Antistatic castors
- Effective dimensions: 530 × 325 mm
- Without insert tray, available as accessory
- Stainless steel



	Dimensions W × D × H mm	Product code
ZT 627/400/715-1200	627 × 400 × 715	7500858



Operating theatre disposal trolley for containers

- Pair of hook-on insert rails
- Welded insert rail pairs
- Antistatic castors
- Stainless steel



	Dimensions W × D × H mm	Product code
ESCW 650/410/900	650 × 410 × 900	7500753



Insert plate for operating theatre disposal trolley

- Perforated
- For placing on L-shaped rails
- Stainless steel



	Dimensions W × D × H mm	Product code
EiBl 300/600/15 gel	600 × 300 × 15	7504373



CJD transport trolley

- Incl. 2 special containers 21 l with handles on top
- Container dimensions: 530 × 325 mm
- Stainless steel



	Dimensions W × D × H mm	Product code
ESW/Creutzfeld-Jakob 635/975/915	975 × 635 × 915	7504541



Universal stainless steel container as insert tray

- External dimensions: 530 × 325 mm
- Material thickness: 0.8 mm
- Stainless steel

	Dimensions W × D × H mm	Product code
BGN 1/1-20	530 × 325 × 20	0130602H
BGN 1/1-40	530 × 325 × 40	0130612H
BGN 1/1-65	530 × 325 × 65	0130622H



Special transport trolleys



Basket trolleys / basket dispensers

Basket dolly and basket dispensers offer space for a large number of baskets and facilitate intermediate storage, transport and material storage at the workplace.



Basket trolley for StU baskets

- Up to 2 stacks of StU baskets 600 × 300 mm
- Platform height: 202 mm
- Antistatic castors
- Stainless steel



	Dimensions W × D × H mm	Product code
KR 60-60 StE	791 × 676 × 856	7500196



Basket dispenser for ISO and StU

- convenient taking of the baskets
- constant working height
- easy placement
- optimum hygiene



	Dimensions W × D × H mm	Product code
OKO 61-41 1xISO/SPRI	831 × 510 × 900	7506313
OKO 61-41 ISO/SPRI	802 × 715 × 899	7504874
OKO 61-61 StE	829 × 715 × 900	7504872



Paper holders

Whether in the operating room or the sterilisation unit, Hupfer paper holder trolley are safe and easy to use and provide practical and reliable assistance wherever they are needed.



Paper holder trolley

- With 4 holder frames \varnothing 25 mm
- Frame height: 905 mm
- Stainless steel



	Dimensions W × D × H mm	Product code
MobPS 1416/718/995	1416 × 718 × 995	7500371



Wired shelf for paper holder

- Electropolished stainless steel



	Dimensions W × D × H mm	Product code
BR 1130/663/154	1130 × 663 × 154	7500372

Special transport trolleys

Platform trolley

Hupfer platform trolleys are versatile and extremely high load-bearing helpers, from transport to intermediate storage and provision at the place of use. As single-ended or heavy-duty platform trolleys with a particularly sturdy construction, they can easily cope with heavy loads.



Platform trolley

- With deep drawn shelf
- Shelf height: 287 mm
- Stainless steel



	Dimensions W × D × H mm	Product code
PW 8x5	895 × 595 × 1012	0112602
PW 5,4x5,4	708 × 606 × 1024	0112662
PW 10x6	1095 × 695 × 1012	0112632
PW 8,2x5,4	983 × 605 × 1020	0112692



Heavy-duty platform trolley

- Payload: 500 kg
- With smooth shelf
- Stainless steel



	Dimensions W × D × H mm	Product code
STWP 8,5x5	970 × 500 × 944	0114192
STWP 10x7	1117 × 700 × 938	0114212



Heavy-duty platform trolley

- Payload: 500 kg
- Platform height: 265 mm
- Stainless steel



	Dimensions W × D × H mm	Product code
TW/s 12 × 6	1366 × 660 × 1054	0162578



Shelving systems

SHELVING SYSTEMS

03



Hupfer shelving systems offer tailor-made solutions for storing, stocking and providing everything from sterile supplies and working materials to consumables and equipment, The large selection of dimensions, overlays, combination options, material and equipment variants sets no limits even to the configuration of complex shelving systems.



Hupfer shelving: designed for flexibility

Hupfer shelving can be precisely adapted to all spatial conditions. The available storage space is thus used optimally and thus economically. The principle: Each Hupfer shelving consists of 2 uprights, 4 shelves and a cross brace.

This basic shelving unit is extended with an upright and 4 shelves. If a 90° corner connection is required, this is done using corner hooks – without the need for superfluous and space-consuming uprights.



The basic shelving unit

For each basic shelving unit which is set up individually, you need two uprights.

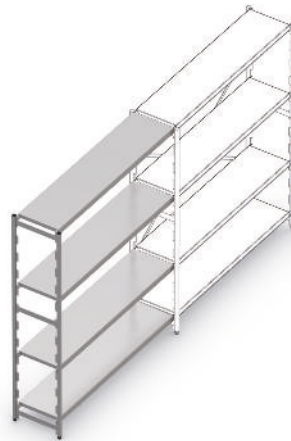

The extension unit

For the extension unit you only need one upright for each additional section, i.e. for 2 sections, 3 uprights. Almost all shelving units can be extended in increments of 10 cm.

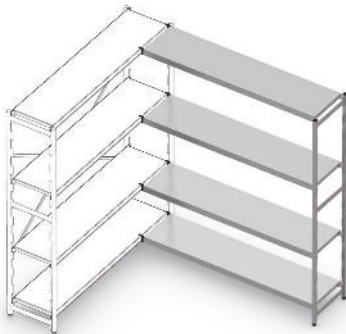

The 90° corner connection

For every shelving system, the 90° corner connection uses simple clip-on corner hooks (2 for each shelf). No superfluous uprights are necessary.

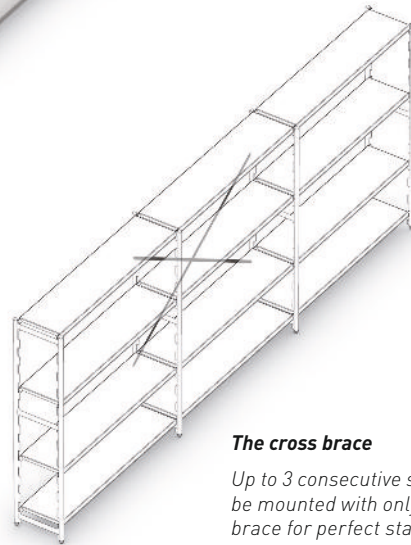

The cross brace

Up to 3 consecutive sections can be mounted with only one cross brace for perfect stability.



The double shelving unit

The back-to-back assembly increases the usable depth of the section. As the uprights are bolted together, there is no need for an additional cross brace compared to the single shelving unit.

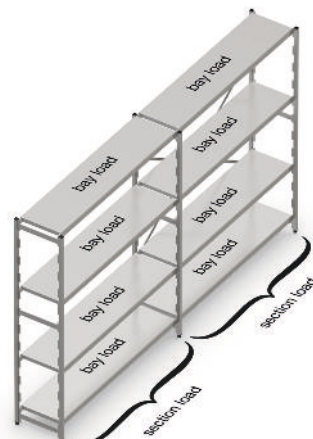

The bay load is the evenly distributed load on a single shelf.

The sum of the bay loads in a section may not exceed the max. section load.



Well thought out down to the last detail



Robust

The robust stainless steel construction, high-quality components and high manufacturing quality ensure reliability and longevity even under tough conditions.



Clearly arranged

Easily attachable shelf dividers help keep things tidy. They are available for shelves in depths of 500 and 600 mm.



Variable

The individual shelves can be exchanged at any time after assembly without tools or repositioned according to the stored goods..



Stable

The standard height-adjustable screw feet compensate for uneven floors up to 25 mm.



Hygienic

The flat cross-connections are positively connected to the uprights using a state-of-the-art, patented method. This prevents blind spots and cavities to allow thorough cleaning without any problems.



Versatile

Solid shelves, polymer shelves or stainless steel louvred shelves are available for different requirements.



Protected

The equipment with flat top, base as well as side and rear panel offers reliable protection against dust and dirt.



Mobile

Some shelving types are available with castors as an optional extra and can be moved without much effort – cleaning, for example.

Norm 5 stationary shelving

The Norm 5 shelving unit sets the standards in terms of performance, hygiene and easy cleaning. Robust, versatile and long-lasting, this shelving system is available for every conceivable storage item.



SHELVING SYSTEMS
03



INOX
ATZINI E&C ATZINI

Stationary shelving set norm 5 with solid shelf



Stationary shelving set norm 5 with solid shelf – height 1200 mm

Width mm	For upright depth 300 mm	For upright depth 400 mm	For upright depth 500 mm	For upright depth 600 mm
	Product code	Product code	Product code	Product code
600	N5GS6003001200	N5GS6004001200	N5GS6005001200	N5GS6006001200
700	N5GS7003001200	N5GS7004001200	N5GS7005001200	N5GS7006001200
800	N5GS8003001200	N5GS8004001200	N5GS8005001200	N5GS8006001200
900	N5GS9003001200	N5GS9004001200	N5GS9005001200	N5GS9006001200
1000	N5GS10003001200	N5GS10004001200	N5GS10005001200	N5GS10006001200
1100	N5GS11003001200	N5GS11004001200	N5GS11005001200	N5GS11006001200
1200	N5GS12003001200	N5GS12004001200	N5GS12005001200	N5GS12006001200
1300	N5GS13003001200	N5GS13004001200	N5GS13005001200	N5GS13006001200
1400	N5GS14003001200	N5GS14004001200	N5GS14005001200	N5GS14006001200
1500	N5GS15003001200	N5GS15004001200	N5GS15005001200	N5GS15006001200



Stationary shelving set norm 5 with solid shelf – height 1400 mm

Width mm	For upright depth 300 mm	For upright depth 400 mm	For upright depth 500 mm	For upright depth 600 mm
	Product code	Product code	Product code	Product code
600	N5GS6003001400	N5GS6004001400	N5GS6005001400	N5GS6006001400
700	N5GS7003001400	N5GS7004001400	N5GS7005001400	N5GS7006001400
800	N5GS8003001400	N5GS8004001400	N5GS8005001400	N5GS8006001400
900	N5GS9003001400	N5GS9004001400	N5GS9005001400	N5GS9006001400
1000	N5GS10003001400	N5GS10004001400	N5GS10005001400	N5GS10006001400
1100	N5GS11003001400	N5GS11004001400	N5GS11005001400	N5GS11006001400
1200	N5GS12003001400	N5GS12004001400	N5GS12005001400	N5GS12006001400
1300	N5GS13003001400	N5GS13004001400	N5GS13005001400	N5GS13006001400
1400	N5GS14003001400	N5GS14004001400	N5GS14005001400	N5GS14006001400
1500	N5GS15003001400	N5GS15004001400	N5GS15005001400	N5GS15006001400

Norm 5 stationary shelving



Stationary shelving set norm 5 with solid shelv– height 1600 mm

Width mm	For upright depth 300 mm	For upright depth 400 mm	For upright depth 500 mm	For upright depth 600 mm
	Product code	Product code	Product code	Product code
600	N5GS6003001600	N5GS6004001600	N5GS6005001600	N5GS6006001600
700	N5GS7003001600	N5GS7004001600	N5GS7005001600	N5GS7006001600
800	N5GS8003001600	N5GS8004001600	N5GS8005001600	N5GS8006001600
900	N5GS9003001600	N5GS9004001600	N5GS9005001600	N5GS9006001600
1000	N5GS10003001600	N5GS10004001600	N5GS10005001600	N5GS10006001600
1100	N5GS11003001600	N5GS11004001600	N5GS11005001600	N5GS11006001600
1200	N5GS12003001600	N5GS12004001600	N5GS12005001600	N5GS12006001600
1300	N5GS13003001600	N5GS13004001600	N5GS13005001600	N5GS13006001600
1400	N5GS14003001600	N5GS14004001600	N5GS14005001600	N5GS14006001600
1500	N5GS15003001600	N5GS15004001600	N5GS15005001600	N5GS15006001600



Stationary shelving set norm 5 with solid shelf – height 1800 mm

Width mm	For upright depth 300 mm	For upright depth 400 mm	For upright depth 500 mm	For upright depth 600 mm
	Product code	Product code	Product code	Product code
600	N5GS6003001800	N5GS6004001800	N5GS6005001800	N5GS6006001800
700	N5GS7003001800	N5GS7004001800	N5GS7005001800	N5GS7006001800
800	N5GS8003001800	N5GS8004001800	N5GS8005001800	N5GS8006001800
900	N5GS9003001800	N5GS9004001800	N5GS9005001800	N5GS9006001800
1000	N5GS10003001800	N5GS10004001800	N5GS10005001800	N5GS10006001800
1100	N5GS11003001800	N5GS11004001800	N5GS11005001800	N5GS11006001800
1200	N5GS12003001800	N5GS12004001800	N5GS12005001800	N5GS12006001800
1300	N5GS13003001800	N5GS13004001800	N5GS13005001800	N5GS13006001800
1400	N5GS14003001800	N5GS14004001800	N5GS14005001800	N5GS14006001800
1500	N5GS15003001800	N5GS15004001800	N5GS15005001800	N5GS15006001800



Stationary shelving set norm 5 with solid shelf – height 2000 mm

Width mm	For upright depth 300 mm	For upright depth 400 mm	For upright depth 500 mm	For upright depth 600 mm
	Product code	Product code	Product code	Product code
600	N5GS6003002000	N5GS6004002000	N5GS6005002000	N5GS6006002000
700	N5GS7003002000	N5GS7004002000	N5GS7005002000	N5GS7006002000
800	N5GS8003002000	N5GS8004002000	N5GS8005002000	N5GS8006002000
900	N5GS9003002000	N5GS9004002000	N5GS9005002000	N5GS9006002000
1000	N5GS10003002000	N5GS10004002000	N5GS10005002000	N5GS10006002000
1100	N5GS11003002000	N5GS11004002000	N5GS11005002000	N5GS11006002000
1200	N5GS12003002000	N5GS12004002000	N5GS12005002000	N5GS12006002000
1300	N5GS13003002000	N5GS13004002000	N5GS13005002000	N5GS13006002000
1400	N5GS14003002000	N5GS14004002000	N5GS14005002000	N5GS14006002000
1500	N5GS15003002000	N5GS15004002000	N5GS15005002000	N5GS15006002000



Norm 5 stationary shelving

Stationary shelving set norm 5 with louvred shelf



Stationary shelving set norm 5 with louvred shelf – height 1200 mm

Width mm	For upright depth 300 mm	For upright depth 400 mm	For upright depth 500 mm	For upright depth 600 mm
	Product code	Product code	Product code	Product code
600	N5BR6003001200	N5BR6004001200	N5BR6005001200	N5BR6006001200
700	N5BR7003001200	N5BR7004001200	N5BR7005001200	N5BR7006001200
800	N5BR8003001200	N5BR8004001200	N5BR8005001200	N5BR8006001200
900	N5BR9003001200	N5BR9004001200	N5BR9005001200	N5BR9006001200
1000	N5BR10003001200	N5BR10004001200	N5BR10005001200	N5BR10006001200
1100	N5BR11003001200	N5BR11004001200	N5BR11005001200	N5BR11006001200
1200	N5BR12003001200	N5BR12004001200	N5BR12005001200	N5BR12006001200
1300	N5BR13003001200	N5BR13004001200	N5BR13005001200	N5BR13006001200
1400	N5BR14003001200	N5BR14004001200	N5BR14005001200	N5BR14006001200
1500	N5BR15003001200	N5BR15004001200	N5BR15005001200	N5BR15006001200





Stationary shelving set norm 5 with louvred shelf – height 1400 mm

Width mm	For upright depth 300 mm	For upright depth 400 mm	For upright depth 500 mm	For upright depth 600 mm
	Product code	Product code	Product code	Product code
600	N5BR6003001400	N5BR6004001400	N5BR6005001400	N5BR6006001400
700	N5BR7003001400	N5BR7004001400	N5BR7005001400	N5BR7006001400
800	N5BR8003001400	N5BR8004001400	N5BR8005001400	N5BR8006001400
900	N5BR9003001400	N5BR9004001400	N5BR9005001400	N5BR9006001400
1000	N5BR10003001400	N5BR10004001400	N5BR10005001400	N5BR10006001400
1100	N5BR11003001400	N5BR11004001400	N5BR11005001400	N5BR11006001400
1200	N5BR12003001400	N5BR12004001400	N5BR12005001400	N5BR12006001400
1300	N5BR13003001400	N5BR13004001400	N5BR13005001400	N5BR13006001400
1400	N5BR14003001400	N5BR14004001400	N5BR14005001400	N5BR14006001400
1500	N5BR15003001400	N5BR15004001400	N5BR15005001400	N5BR15006001400



Stationary shelving set norm 5 with louvred shelf – height 1600 mm

Width mm	For upright depth 300 mm	For upright depth 400 mm	For upright depth 500 mm	For upright depth 600 mm
	Product code	Product code	Product code	Product code
600	N5BR6003001600	N5BR6004001600	N5BR6005001600	N5BR6006001600
700	N5BR7003001600	N5BR7004001600	N5BR7005001600	N5BR7006001600
800	N5BR8003001600	N5BR8004001600	N5BR8005001600	N5BR8006001600
900	N5BR9003001600	N5BR9004001600	N5BR9005001600	N5BR9006001600
1000	N5BR10003001600	N5BR10004001600	N5BR10005001600	N5BR10006001600
1100	N5BR11003001600	N5BR11004001600	N5BR11005001600	N5BR11006001600
1200	N5BR12003001600	N5BR12004001600	N5BR12005001600	N5BR12006001600
1300	N5BR13003001600	N5BR13004001600	N5BR13005001600	N5BR13006001600
1400	N5BR14003001600	N5BR14004001600	N5BR14005001600	N5BR14006001600
1500	N5BR15003001600	N5BR15004001600	N5BR15005001600	N5BR15006001600

Norm 5 stationary shelving



Stationary shelving set norm 5 with louvred shelf – height 1800 mm

Width mm	For upright depth 300 mm	For upright depth 400 mm	For upright depth 500 mm	For upright depth 600 mm
	Product code	Product code	Product code	Product code
600	N5BR6003001800	N5BR6004001800	N5BR6005001800	N5BR6006001800
700	N5BR7003001800	N5BR7004001800	N5BR7005001800	N5BR7006001800
800	N5BR8003001800	N5BR8004001800	N5BR8005001800	N5BR8006001800
900	N5BR9003001800	N5BR9004001800	N5BR9005001800	N5BR9006001800
1000	N5BR10003001800	N5BR10004001800	N5BR10005001800	N5BR10006001800
1100	N5BR11003001800	N5BR11004001800	N5BR11005001800	N5BR11006001800
1200	N5BR12003001800	N5BR12004001800	N5BR12005001800	N5BR12006001800
1300	N5BR13003001800	N5BR13004001800	N5BR13005001800	N5BR13006001800
1400	N5BR14003001800	N5BR14004001800	N5BR14005001800	N5BR14006001800
1500	N5BR15003001800	N5BR15004001800	N5BR15005001800	N5BR15006001800



Stationary shelving set norm 5 with louvred shelf – height 2000 mm

Width mm	For upright depth 300 mm	For upright depth 400 mm	For upright depth 500 mm	For upright depth 600 mm
	Product code	Product code	Product code	Product code
600	N5BR6003002000	N5BR6004002000	N5BR6005002000	N5BR6006002000
700	N5BR7003002000	N5BR7004002000	N5BR7005002000	N5BR7006002000
800	N5BR8003002000	N5BR8004002000	N5BR8005002000	N5BR8006002000
900	N5BR9003002000	N5BR9004002000	N5BR9005002000	N5BR9006002000
1000	N5BR10003002000	N5BR10004002000	N5BR10005002000	N5BR10006002000
1100	N5BR11003002000	N5BR11004002000	N5BR11005002000	N5BR11006002000
1200	N5BR12003002000	N5BR12004002000	N5BR12005002000	N5BR12006002000
1300	N5BR13003002000	N5BR13004002000	N5BR13005002000	N5BR13006002000
1400	N5BR14003002000	N5BR14004002000	N5BR14005002000	N5BR14006002000
1500	N5BR15003002000	N5BR15004002000	N5BR15005002000	N5BR15006002000

Stationary shelving set norm 5 with wired shelf



Stationary shelving set norm 5 with wired shelf – height 1200 mm

Width mm	For upright depth 300 mm	For upright depth 400 mm	For upright depth 500 mm	For upright depth 600 mm
	Product code	Product code	Product code	Product code
600	N5DR6003001200	N5DR6004001200	N5DR6005001200	N5DR6006001200
700	N5DR7003001200	N5DR7004001200	N5DR7005001200	N5DR7006001200
800	N5DR8003001200	N5DR8004001200	N5DR8005001200	N5DR8006001200
900	N5DR9003001200	N5DR9004001200	N5DR9005001200	N5DR9006001200
1000	N5DR10003001200	N5DR10004001200	N5DR10005001200	N5DR10006001200
1100	N5DR11003001200	N5DR11004001200	N5DR11005001200	N5DR11006001200
1200	N5DR12003001200	N5DR12004001200	N5DR12005001200	N5DR12006001200
1300	N5DR13003001200	N5DR13004001200	N5DR13005001200	N5DR13006001200
1400	N5DR14003001200	N5DR14004001200	N5DR14005001200	N5DR14006001200
1500	N5DR15003001200	N5DR15004001200	N5DR15005001200	N5DR15006001200



Norm 5 stationary shelving



Stationary shelving set norm 5 with wired shelf – height 1400 mm

Width mm	For upright depth 300 mm	For upright depth 400 mm	For upright depth 500 mm	For upright depth 600 mm
	Product code	Product code	Product code	Product code
600	N5DR6003001400	N5DR6004001400	N5DR6005001400	N5DR6006001400
700	N5DR7003001400	N5DR7004001400	N5DR7005001400	N5DR7006001400
800	N5DR8003001400	N5DR8004001400	N5DR8005001400	N5DR8006001400
900	N5DR9003001400	N5DR9004001400	N5DR9005001400	N5DR9006001400
1000	N5DR10003001400	N5DR10004001400	N5DR10005001400	N5DR10006001400
1100	N5DR11003001400	N5DR11004001400	N5DR11005001400	N5DR11006001400
1200	N5DR12003001400	N5DR12004001400	N5DR12005001400	N5DR12006001400
1300	N5DR13003001400	N5DR13004001400	N5DR13005001400	N5DR13006001400
1400	N5DR14003001400	N5DR14004001400	N5DR14005001400	N5DR14006001400
1500	N5DR15003001400	N5DR15004001400	N5DR15005001400	N5DR15006001400



Stationary shelving set norm 5 with wired shelf – height 1600 mm

Width mm	For upright depth 300 mm	For upright depth 400 mm	For upright depth 500 mm	For upright depth 600 mm
	Product code	Product code	Product code	Product code
600	N5DR6003001600	N5DR6004001600	N5DR6005001600	N5DR6006001600
700	N5DR7003001600	N5DR7004001600	N5DR7005001600	N5DR7006001600
800	N5DR8003001600	N5DR8004001600	N5DR8005001600	N5DR8006001600
900	N5DR9003001600	N5DR9004001600	N5DR9005001600	N5DR9006001600
1000	N5DR10003001600	N5DR10004001600	N5DR10005001600	N5DR10006001600
1100	N5DR11003001600	N5DR11004001600	N5DR11005001600	N5DR11006001600
1200	N5DR12003001600	N5DR12004001600	N5DR12005001600	N5DR12006001600
1300	N5DR13003001600	N5DR13004001600	N5DR13005001600	N5DR13006001600
1400	N5DR14003001600	N5DR14004001600	N5DR14005001600	N5DR14006001600
1500	N5DR15003001600	N5DR15004001600	N5DR15005001600	N5DR15006001600



Stationary shelving set norm 5 with wired shelf – height 1800 mm

Width mm	For upright depth 300 mm	For upright depth 400 mm	For upright depth 500 mm	For upright depth 600 mm
	Product code	Product code	Product code	Product code
600	N5DR6003001800	N5DR6004001800	N5DR6005001800	N5DR6006001800
700	N5DR7003001800	N5DR7004001800	N5DR7005001800	N5DR7006001800
800	N5DR8003001800	N5DR8004001800	N5DR8005001800	N5DR8006001800
900	N5DR9003001800	N5DR9004001800	N5DR9005001800	N5DR9006001800
1000	N5DR10003001800	N5DR10004001800	N5DR10005001800	N5DR10006001800
1100	N5DR11003001800	N5DR11004001800	N5DR11005001800	N5DR11006001800
1200	N5DR12003001800	N5DR12004001800	N5DR12005001800	N5DR12006001800
1300	N5DR13003001800	N5DR13004001800	N5DR13005001800	N5DR13006001800
1400	N5DR14003001800	N5DR14004001800	N5DR14005001800	N5DR14006001800
1500	N5DR15003001800	N5DR15004001800	N5DR15005001800	N5DR15006001800



Stationary shelving set norm 5 with wired shelf – height 2000 mm

Width mm	For upright depth 300 mm	For upright depth 400 mm	For upright depth 500 mm	For upright depth 600 mm
	Product code	Product code	Product code	Product code
600	N5DR6003002000	N5DR6004002000	N5DR6005002000	N5DR6006002000
700	N5DR7003002000	N5DR7004002000	N5DR7005002000	N5DR7006002000
800	N5DR8003002000	N5DR8004002000	N5DR8005002000	N5DR8006002000
900	N5DR9003002000	N5DR9004002000	N5DR9005002000	N5DR9006002000
1000	N5DR10003002000	N5DR10004002000	N5DR10005002000	N5DR10006002000
1100	N5DR11003002000	N5DR11004002000	N5DR11005002000	N5DR11006002000
1200	N5DR12003002000	N5DR12004002000	N5DR12005002000	N5DR12006002000
1300	N5DR13003002000	N5DR13004002000	N5DR13005002000	N5DR13006002000
1400	N5DR14003002000	N5DR14004002000	N5DR14005002000	N5DR14006002000
1500	N5DR15003002000	N5DR15004002000	N5DR15005002000	N5DR15006002000

Norm 5 stationary shelving

Norm 5 shelving unit elements



Norm 5 upright – max. section load 600 kg

Height mm	For upright depth 300 mm	For upright depth 400 mm	For upright depth 500 mm	For upright depth 600 mm
	Product code	Product code	Product code	Product code
1200	0101007	0101017	0101037	0101047
1400	0101077	0101087	0101107	0101117
1600	0101147	0101157	0101177	0101187
1800	0101217	0101227	0101247	0101257
2000	0101287	0101297	0101317	0101327



Norm 5 upright – max. section load 1200 kg

- Stainless steel
- Pitch 150 mm

Height mm	For upright depth 300 mm	For upright depth 400 mm	For upright depth 500 mm	For upright depth 600 mm
	Product code	Product code	Product code	Product code
1800	0101215	0101225	0101245	0101255
2000	0101285	0101295	0101315	0101325





Norm 5 solid shelf

- easy to clean
- perfect hygiene
- high weight capacity
- easy handling

Width mm	For upright depth 300 mm	For upright depth 400 mm	For upright depth 500 mm	For upright depth 600 mm
	Product code	Product code	Product code	Product code
600	0102432	0102442	0102462	0102472
700	0102522	0102552	0102562	0102592
800	0102502	0102512	0102532	0102542
900	0102572	0102582	0102602	0102612
1000	0102642	0102652	0102672	0102682
1100	0102622	0102632	0102662	0102692
1200	0102712	0102722	0102742	0102752
1300	0102732	0102762	0102772	0102872
1400	0102782	0102792	0102812	0102822
1500	0102852	0102862	0102882	0102892



Norm 5 louvred shelf

- Stainless steel
- Bay load: 150 kg

Width mm	For upright depth 300 mm	For upright depth 400 mm	For upright depth 500 mm	For upright depth 600 mm
	Product code	Product code	Product code	Product code
600	0101537	0101547	0101567	0101577
700	0101527	0101557	0101587	0101597
800	0101607	0101617	0101637	0101647
900	0101677	0101687	0101707	0101717
1000	0101747	0101757	0101777	0101787
1100	0101657	0101767	0101797	0101837
1200	0101817	0101827	0101847	0101857
1300	0101867	0101877	0101937	0101947
1400	0101887	0101897	0101917	0101927
1500	0101957	0101967	0101987	0101997

Norm 5 stationary shelving



Norm 5 wired shelf

- Well ventilated storage
- perfect hygiene
- high weight capacity
- easy handling

Width mm	For upright depth 300 mm	For upright depth 400 mm	For upright depth 500 mm	For upright depth 600 mm
	Product code	Product code	Product code	Product code
600	0101532	0101542	0101562	0101572
700	0101522	0101552	0101582	0101592
800	0101602	0101612	0101632	0101642
900	0101672	0101682	0101702	0101712
1000	0101742	0101752	0101772	0101782
1100	0101652	0101762	0101792	0101832
1200	0101812	0101822	0101842	0101852
1300	0101862	0101872	0101932	0101942
1400	0101882	0101892	0101912	0101922
1500	0101952	0101962	0101982	0101992



Norm 5 cross brace

- Requires 1 in every 3rd section
- Suitable for all shelf widths and uprights



	Dimensions W × D × H mm	Product code
RG-KV/N5/12/20/25	1009 × 48 × 934	0103072



Norm 5 cross brace for back-to-back assembly

- Complements the cross brace
- An additional cross brace is required for assembly.
- Stainless steel



	Dimensions W × D × H mm	Product code
SSet-RR N5/25	44 × 44 × 153	0115733



Push-through protection for shelves

- For attachment between two uprights on the broadside of a shelf
- Height: 130 mm
- Electropolished stainless steel

Width mm	Product code
600	0117411
700	0117418
800	0117412
900	0117413
1000	0117414
1200	0117415
1300	0117419
1400	0117416
1500	0117417



Push-through protection for uprights

- maximum safety
- Effortless hooking in and removal
- space-saving
- electropolished
- hard-wearing



Height mm	For upright depth 500 mm	For upright depth 600 mm
	Product code	Product code
1800	0130451	0130452
2000	0130453	0130454



Norm 5 reinforcing beams

- high-quality stainless steel
- easy assembly
- Optimum distribution of the weight
- Increased weight capacity of the shelf



Depth mm	Product code
400	0102100
600	0102102
300	0102099
500	0102101

Norm 5 stationary shelving



Push-through protection

- Electropolished stainless steel
- For side attachment

Depth mm	Product code
500	0117402
600	0117403



Bracing bar

- Stainless steel
- As an alternative to the cross brace for loading the shelf from both sides
- With fixing material
- 4 long rails required per section



Width mm	Product code
600	0117022
700	0117030
800	0117023
900	0117024
1000	0117025
1200	0117026
1300	0117031
1400	0117027



Corner hook for wire shelved

- For corner connections
- For wire shelves



	Dimensions W × D × H mm	Product code
RG-EVK N5	32 × 19 × 21	0103122



Corner hook for solid and louvred shelves

- For corner connections
- For louvred shelves and solid shelves

	Dimensions W × D × H mm	Product code
RG-EVK N5/20/25	46 × 22 × 64	0203126



Shelf divider

- Stainless steel
- For enclosed systems

Height mm	For upright depth 500 mm	For upright depth 600 mm
	Product code	Product code
210	7504221	7504220
260	7506198	7506197



Shelf railing

- Stainless steel
- To stop items falling out of the front or back
- With plastic end caps

Width mm	Product code
600	0115242
700	0115241
800	0115243
900	0115244
1000	0115245
1200	0115246
1300	0115249
1400	0115247

Norm 5 stationary shelving



Shelf railing holder

- Stainless steel
- Infinitely height-adjustable.
- For use with shelf railing



	Dimensions W × D × H mm	Product code
RG-SLH	42 × 30 × 60	0115252



Weight distribution plate

- Aluminium



	Dimensions W × D × H mm	Product code
BVP/N20 115/115/6	115 × 115 × 6	0203142



Hanging rail support

- Stainless steel
- For attaching hanging rails
- Also to secure the stored items from the sides



Depth mm	Product code
400	0123592
500	0123602
600	0123612
300	0123582



Hanging rail

- Aluminium
- For hanging between two uprights
- For attaching hooks
- Universal rail 45 x 10 mm

Width mm	Product code
600	0203162
700	0203232
800	0203172
900	0203182
1000	0203192
1200	0203202
1300	0203242
1400	0203212



Ceiling or floor fixing attachment

- Stainless steel
- For additional securing of shelves.
- Without fixing material

	Dimensions W × D × H mm	Product code
RG-DBBF/N5/12/20/25/28	70 × 29 × 202	0103152



Wall mounting

- Stainless steel
- For upright

	Dimensions W × D × H mm	Product code
RG-WBF/N5	77 × 36 × 18	0116032



Norm 5 stationary shelving



Wallfixing

- Stainless steel
- For uprights used against walls with coving.
- For 25 x 25 mm tube
- Without fixing material



	Dimensions W × D × H mm	Product code
RG-HWBF/N5	85 × 68 × 58	0116031



Dunnage rack

- Stainless steel
- Total load capacity of 200 kg



	Dimensions W × D × H mm	Product code
RG-BR/N5 1000/550/300	1000 × 550 × 300	0114452
RG-BR/N5 1200/550/300	1200 × 550 × 300	0114492



Norm 5 Medidul stationary shelving

This version of the tried-and-tested shelving system is specially designed for operating theatres and sterile supplies storage areas. Whether in soft packaging in baskets or in containers – sterile supplies are stored safely and clearly on U-shape profile rails or L-shape profile rails.



SHELVING SYSTEMS

03



Norm 5 Medidul shelving unit elements



Norm 5 Medidul upright

- Stainless steel
- Maximum section load: 600 kg

Height mm	For upright depth 300 mm	For upright depth 400 mm	For upright depth 500 mm	For upright depth 600 mm
	Product code	Product code	Product code	Product code
1800	-	7505114	-	7505105
2000	7505113	7505115	7505117	7505106



Norm 5 Medidul solid shelf

- Stainless steel

Width mm	For upright depth 600 mm
	Product code
355	7505004
455	7505008



Medidul cross brace

- Requires 1 in every 3rd section
- Stainless steel

	Dimensions W × D × H mm	Product code
RG-KV/N5 Medidul	1009 × 24 × 934	7505019
RG-KV/N5 Medidul StE		7505612
RG-KV/N5 Medidul ISO		7505611

Norm 5 Medidul stationary shelving

Medidul bracing bars



- Stainless steel
- For uprights with 600 kg section load
- For uprights with 75 mm pitch
- Packaging unit: 4 per section
- For upright depth 600 mm



Width mm	For upright depth 600 mm	Product code
355		7505024
455		7505025

Medidul L-shape profile rail



- Package content: 1 pair
- Bearing face 60 mm
- Stainless steel



	Insertions	Dimensions W × D × H mm	Product code
RG-ESS/L MEDIDUL 594/84/39	L-shape profile rails	594 × 84 × 39	7504213

Medidul L-shape profile with push-through protection



- With push-through protection
- Stainless steel



	Dimensions W × D × H mm	Product code
RG-ESS/L MEDIDUL 594/84/39 mD	594 × 349 × 39	7506479

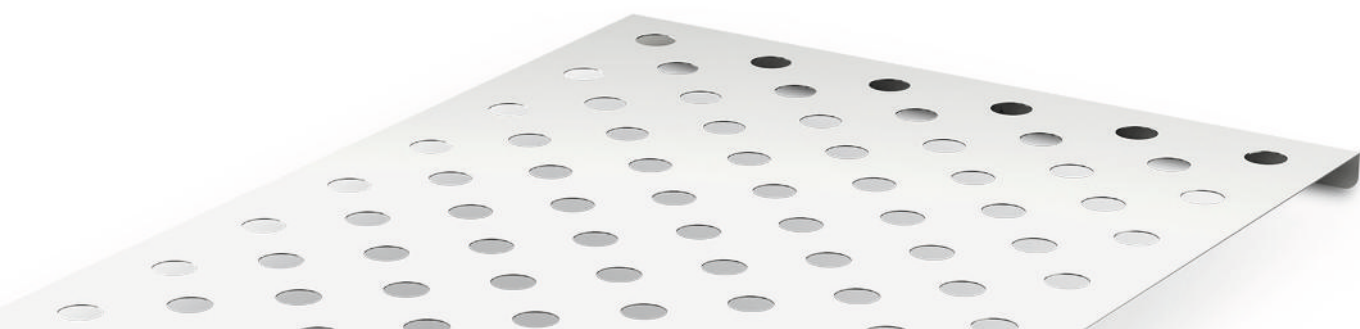



Medidul U-shape profile rail

- Package content: 1 pair
- Bearing face 14 mm
- Stainless steel



	Insertions	Product code
RG-ESS/U MEDIDUL 36/570/41	U-shape profile rails	7505009



Pull-out frame set

- appr. 3/4 extension
- Stainless steel
- For StU containers and baskets
- For ISO containers and baskets



	Dimensions W × D × H mm	Product code
ERS StE 296/595/60	595 × 296 × 60	7504555
ERS ISO 448/595/66	595 × 448 × 66	7501216



Insert shelf

- Perforated
- For placing on L-shaped rails
- Stainless steel



	Dimensions W × D × H mm	Product code
EiBl 300/600/15 gel	600 × 300 × 15	7504373



Label holder

- Electropolished stainless steel
- Field is magnetic
- Laser marking on request



	Dimensions W × D × H mm	Product code
Sch 85/82/26	85 × 82 × 26	7504932

Norm 5 Medidul stationary shelving



Medidul side panel

- Stainless steel
- For uprights with 75 mm pitch



For upright height
1800 mm

Art.-Nr.
7505210

For upright height
2000 mm

Art.-Nr.
7505211



Medidul rear panel

- Stainless steel



For upright height
1800 mm

Art.-Nr.

For upright height
2000 mm

Art.-Nr.

Width mm	For upright height 1800 mm	For upright height 2000 mm
	Art.-Nr.	Art.-Nr.
355	-	7505222
455	-	7505223
600	7505214	7505224
655	7505215	7505225
800	7505216	7505226
900	7505217	7505227
1000	7505218	7505228
1200	7505219	7505229
1400	7505220	7505230
1500	7505221	7505231

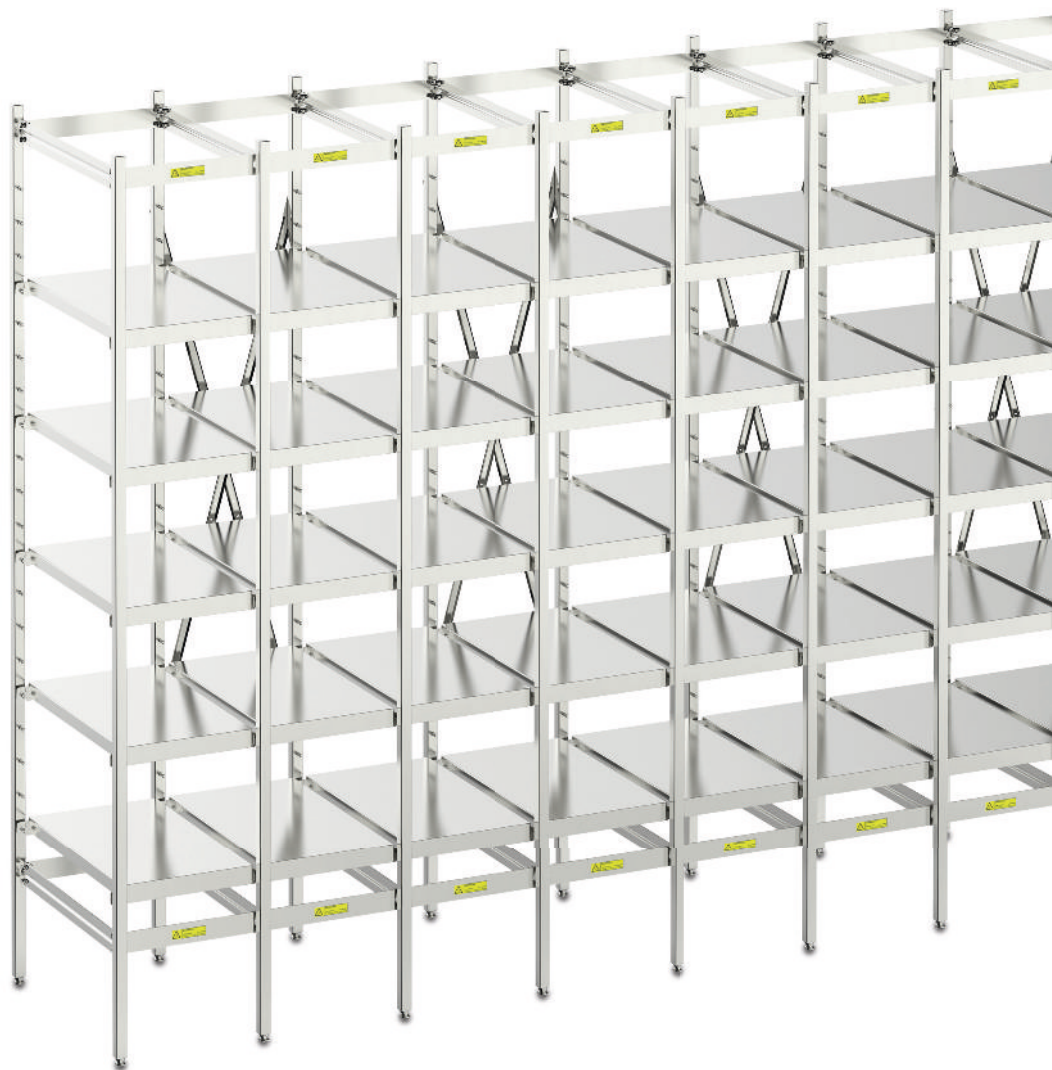

Norm 25 stationary shelving

Rust-free, durable and extremely robust like the Norm 5 shelving unit, this shelf variant offers a special advantage: magnets stick to the special stainless steel alloy so that stored items can be easily, quickly and reliably labelled.



SHELVING SYSTEMS

03



Norm 25 shelving unit elements



Stationary shelving set norm 25 with solid shelf – height 1800 mm

Width mm	For upright depth 500 mm	For upright depth 600 mm
	Product code	Product code
700	N25GS7005001800	N25GS7006001800
800	N25GS8005001800	N25GS8006001800
900	N25GS9005001800	N25GS9006001800
1000	N25GS10005001800	N25GS10006001800
1100	N25GS11005001800	N25GS11006001800
1200	N25GS12005001800	N25GS12006001800
1300	N25GS13005001800	N25GS13006001800
1400	N25GS14005001800	N25GS14006001800



Norm 25 stationary shelving



Norm 25 upright

Height mm	For upright depth 400 mm	For upright depth 500 mm	For upright depth 600 mm
	Product code	Product code	Product code
1800	0137007	0137004	0137005



Norm 25 solid shelf

Width mm	For upright depth 400 mm	For upright depth 500 mm	For upright depth 600 mm
	Product code	Product code	Product code
700	0137006	0137016	0137026
800	0137186	0137046	0137056
900	0137096	0137076	0137086
1000	0137196	0137106	0137116
1100	0137206	0137036	0137066
1200	0137216	0137136	0137146
1300	0137226	0137126	0137210



Norm 25 cross brace

- Requires 1 in every 3rd section
- Suitable for all shelf widths and uprights

	Dimensions W × D × H mm	Product code
RG-KV/N5/12/20/25	1009 × 48 × 934	0103072



Cross brace for back-to-back assembly

- Complements the cross brace
- An additional cross brace is required for assembly.
- Stainless steel

	Dimensions W × D × H mm	Product code
SSet-RR N5/25	44 × 44 × 153	0115733



Corner hook for solid and louvred shelves

- For corner connections
- For louvred shelves and solid shelves

	Dimensions W × D × H mm	Product code
RG-EVK N5/20/25	46 × 22 × 64	0203126

Norm 25 stationary shelving



Push-through protection for shelves

- For attachment between two uprights on the broadside of a shelf
- Height: 130 mm
- Electropolished stainless steel

Width mm	Product code
600	0117411
700	0117418
800	0117412
900	0117413
1000	0117414
1200	0117415
1300	0117419
1400	0117416
1500	0117417

Push-through protection for uprights

- maximum safety
- Effortless hooking in and removal
- space-saving
- electropolished
- hard-wearing



Height mm	For upright depth 500 mm	For upright depth 600 mm
	Product code	Product code
1800	0130451	0130452
2000	0130453	0130454



Push-through protection

- Electropolished stainless steel
- For side attachment



Depth mm	Product code
500	0117402
600	0117403

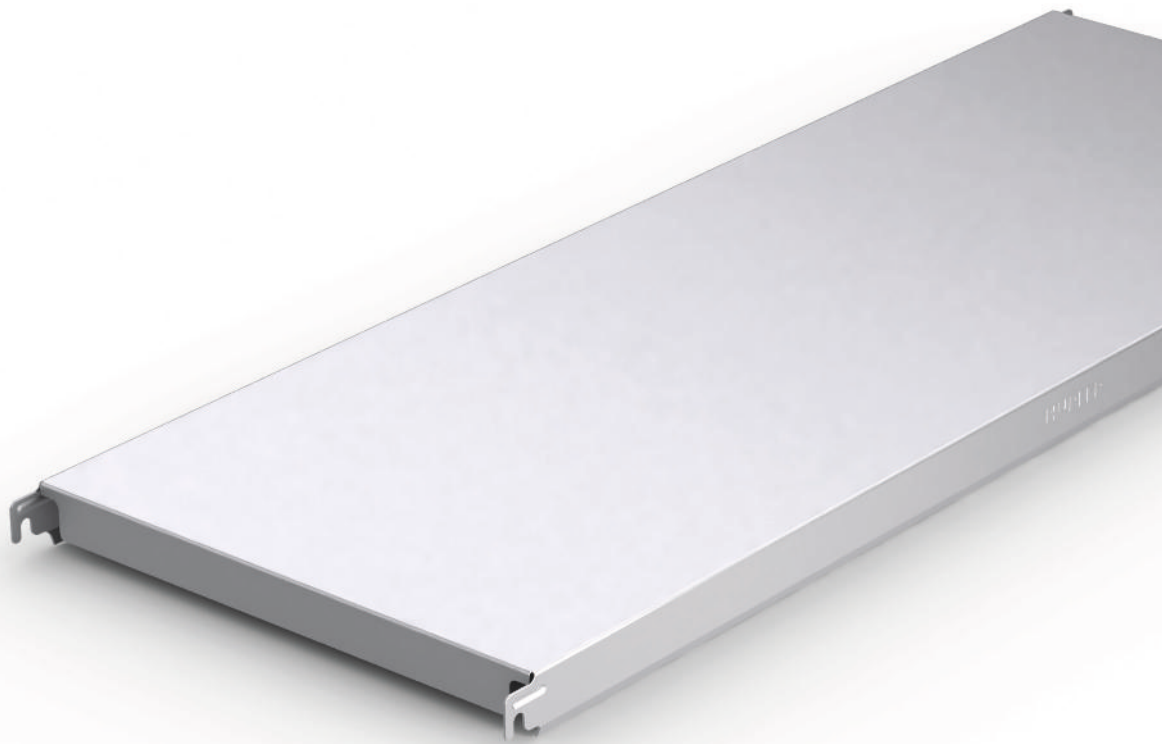

Norm 20 stationary shelving

This shelving system, made of high-quality aluminium, combines low weight with a high loading capacity. Its tidiness and versatility are ideal wherever laundry and consumables are stored.



SHELVING SYSTEMS
03



Stationary shelving set norm 20 with solid shelf



Stationary shelving set norm 20 with solid shelf – height 1200 mm

Width mm	For upright depth 300 mm	For upright depth 400 mm	For upright depth 500 mm	For upright depth 600 mm
	Product code	Product code	Product code	Product code
600	N20GS6003001200	N20GS6004001200	N20GS6005001200	N20GS6006001200
700	N20GS7003001200	N20GS7004001200	N20GS7005001200	N20GS7006001200
800	N20GS8003001200	N20GS8004001200	N20GS8005001200	N20GS8006001200
900	N20GS9003001200	N20GS9004001200	N20GS9005001200	N20GS9006001200
1000	N20GS10003001200	N20GS10004001200	N20GS10005001200	N20GS10006001200
1100	N20GS11003001200	N20GS11004001200	N20GS11005001200	N20GS11006001200
1200	N20GS12003001200	N20GS12004001200	N20GS12005001200	N20GS12006001200
1300	N20GS13003001200	N20GS13004001200	N20GS13005001200	N20GS13006001200
1400	N20GS14003001200	N20GS14004001200	N20GS14005001200	N20GS14006001200
1500	N20GS15003001200	N20GS15004001200	N20GS15005001200	N20GS15006001200



Norm 20 stationary shelving



Stationary shelving set norm 20 with solid shelf – height 1400 mm

Width mm	For upright depth 300 mm	For upright depth 400 mm	For upright depth 500 mm	For upright depth 600 mm
	Product code	Product code	Product code	Product code
600	N20GS6003001400	N20GS6004001400	N20GS6005001400	N20GS6006001400
700	N20GS7003001400	N20GS7004001400	N20GS7005001400	N20GS7006001400
800	N20GS8003001400	N20GS8004001400	N20GS8005001400	N20GS8006001400
900	N20GS9003001400	N20GS9004001400	N20GS9005001400	N20GS9006001400
1000	N20GS10003001400	N20GS10004001400	N20GS10005001400	N20GS10006001400
1100	N20GS11003001400	N20GS11004001400	N20GS11005001400	N20GS11006001400
1200	N20GS12003001400	N20GS12004001400	N20GS12005001400	N20GS12006001400
1300	N20GS13003001400	N20GS13004001400	N20GS13005001400	N20GS13006001400
1400	N20GS14003001400	N20GS14004001400	N20GS14005001400	N20GS14006001400
1500	N20GS15003001400	N20GS15004001400	N20GS15005001400	N20GS15006001400



Stationary shelving set norm 20 with solid shelf – height 1600 mm

Width mm	For upright depth 300 mm	For upright depth 400 mm	For upright depth 500 mm	For upright depth 600 mm
	Product code	Product code	Product code	Product code
600	N20GS6003001600	N20GS6004001600	N20GS6005001600	N20GS6006001600
700	N20GS7003001600	N20GS7004001600	N20GS7005001600	N20GS7006001600
800	N20GS8003001600	N20GS8004001600	N20GS8005001600	N20GS8006001600
900	N20GS9003001600	N20GS9004001600	N20GS9005001600	N20GS9006001600
1000	N20GS10003001600	N20GS10004001600	N20GS10005001600	N20GS10006001600
1100	N20GS11003001600	N20GS11004001600	N20GS11005001600	N20GS11006001600
1200	N20GS12003001600	N20GS12004001600	N20GS12005001600	N20GS12006001600
1300	N20GS13003001600	N20GS13004001600	N20GS13005001600	N20GS13006001600
1400	N20GS14003001600	N20GS14004001600	N20GS14005001600	N20GS14006001600
1500	N20GS15003001600	N20GS15004001600	N20GS15005001600	N20GS15006001600



Stationary shelving set norm 20 with solid shelf – height 1800 mm

Width mm	For upright depth 300 mm	For upright depth 400 mm	For upright depth 500 mm	For upright depth 600 mm
	Product code	Product code	Product code	Product code
600	N20GS6003001800	N20GS6004001800	N20GS6005001800	N20GS6006001800
700	N20GS7003001800	N20GS7004001800	N20GS7005001800	N20GS7006001800
800	N20GS8003001800	N20GS8004001800	N20GS8005001800	N20GS8006001800
900	N20GS9003001800	N20GS9004001800	N20GS9005001800	N20GS9006001800
1000	N20GS10003001800	N20GS10004001800	N20GS10005001800	N20GS10006001800
1100	N20GS11003001800	N20GS11004001800	N20GS11005001800	N20GS11006001800
1200	N20GS12003001800	N20GS12004001800	N20GS12005001800	N20GS12006001800
1300	N20GS13003001800	N20GS13004001800	N20GS13005001800	N20GS13006001800
1400	N20GS14003001800	N20GS14004001800	N20GS14005001800	N20GS14006001800
1500	N20GS15003001800	N20GS15004001800	N20GS15005001800	N20GS15006001800



Stationary shelving set norm 20 with solid shelf – height 2000 mm

Width mm	For upright depth 300 mm	For upright depth 400 mm	For upright depth 500 mm	For upright depth 600 mm
	Product code	Product code	Product code	Product code
600	N20GS6003002000	N20GS6004002000	N20GS6005002000	N20GS6006002000
700	N20GS7003002000	N20GS7004002000	N20GS7005002000	N20GS7006002000
800	N20GS8003002000	N20GS8004002000	N20GS8005002000	N20GS8006002000
900	N20GS9003002000	N20GS9004002000	N20GS9005002000	N20GS9006002000
1000	N20GS10003002000	N20GS10004002000	N20GS10005002000	N20GS10006002000
1100	N20GS11003002000	N20GS11004002000	N20GS11005002000	N20GS11006002000
1200	N20GS12003002000	N20GS12004002000	N20GS12005002000	N20GS12006002000
1300	N20GS13003002000	N20GS13004002000	N20GS13005002000	N20GS13006002000
1400	N20GS14003002000	N20GS14004002000	N20GS14005002000	N20GS14006002000
1500	N20GS15003002000	N20GS15004002000	N20GS15005002000	N20GS15006002000

Norm 20 stationary shelving

Stationary shelving set norm 20 with louvred shelf



Stationary shelving set norm 20 with louvred shelf – height 1200 mm

Width mm	For upright depth 300 mm	For upright depth 400 mm	For upright depth 500 mm	For upright depth 600 mm
	Product code	Product code	Product code	Product code
600	N20AR6003001200	N20AR6004001200	N20AR6005001200	N20AR6006001200
700	N20AR7003001200	N20AR7004001200	N20AR7005001200	N20AR7006001200
800	N20AR8003001200	N20AR8004001200	N20AR8005001200	N20AR8006001200
900	N20AR9003001200	N20AR9004001200	N20AR9005001200	N20AR9006001200
1000	N20AR10003001200	N20AR10004001200	N20AR10005001200	N20AR10006001200
1200	N20AR12003001200	N20AR12004001200	N20AR12005001200	N20AR12006001200
1300	N20AR13003001200	N20AR13004001200	N20AR13005001200	N20AR13006001200
1400	N20AR14003001200	N20AR14004001200	N20AR14005001200	N20AR14006001200
1500	N20AR15003001200	N20AR15004001200	N20AR15005001200	N20AR15006001200



Stationary shelving set norm 20 with louvred shelf – height 1400 mm

Width mm	For upright depth 300 mm	For upright depth 400 mm	For upright depth 500 mm	For upright depth 600 mm
	Product code	Product code	Product code	Product code
600	N20AR6003001400	N20AR6004001400	N20AR6005001400	N20AR6006001400
700	N20AR7003001400	N20AR7004001400	N20AR7005001400	N20AR7006001400
800	N20AR8003001400	N20AR8004001400	N20AR8005001400	N20AR8006001400
900	N20AR9003001400	N20AR9004001400	N20AR9005001400	N20AR9006001400
1000	N20AR10003001400	N20AR10004001400	N20AR10005001400	N20AR10006001400
1200	N20AR12003001400	N20AR12004001400	N20AR12005001400	N20AR12006001400
1300	N20AR13003001400	N20AR13004001400	N20AR13005001400	N20AR13006001400
1400	N20AR14003001400	N20AR14004001400	N20AR14005001400	N20AR14006001400
1500	N20AR15003001400	N20AR15004001400	N20AR15005001400	N20AR15006001400



Stationary shelving set norm 20 with louvred shelf – height 1600 mm

Width mm	For upright depth 300 mm	For upright depth 400 mm	For upright depth 500 mm	For upright depth 600 mm
	Product code	Product code	Product code	Product code
600	N20AR6003001600	N20AR6004001600	N20AR6005001600	N20AR6006001600
700	N20AR7003001600	N20AR7004001600	N20AR7005001600	N20AR7006001600
800	N20AR8003001600	N20AR8004001600	N20AR8005001600	N20AR8006001600
900	N20AR9003001600	N20AR9004001600	N20AR9005001600	N20AR9006001600
1000	N20AR10003001600	N20AR10004001600	N20AR10005001600	N20AR10006001600
1200	N20AR12003001600	N20AR12004001600	N20AR12005001600	N20AR12006001600
1300	N20AR13003001600	N20AR13004001600	N20AR13005001600	N20AR13006001600
1400	N20AR14003001600	N20AR14004001600	N20AR14005001600	N20AR14006001600
1500	N20AR15003001600	N20AR15004001600	N20AR15005001600	N20AR15006001600



Stationary shelving set norm 20 with louvred shelf – height 1800 mm

Width mm	For upright depth 300 mm	For upright depth 400 mm	For upright depth 500 mm	For upright depth 600 mm
	Product code	Product code	Product code	Product code
600	N20AR6003001800	N20AR6004001800	N20AR6005001800	N20AR6006001800
700	N20AR7003001800	N20AR7004001800	N20AR7005001800	N20AR7006001800
800	N20AR8003001800	N20AR8004001800	N20AR8005001800	N20AR8006001800
900	N20AR9003001800	N20AR9004001800	N20AR9005001800	N20AR9006001800
1000	N20AR10003001800	N20AR10004001800	N20AR10005001800	N20AR10006001800
1200	N20AR12003001800	N20AR12004001800	N20AR12005001800	N20AR12006001800
1300	N20AR13003001800	N20AR13004001800	N20AR13005001800	N20AR13006001800
1400	N20AR14003001800	N20AR14004001800	N20AR14005001800	N20AR14006001800
1500	N20AR15003001800	N20AR15004001800	N20AR15005001800	N20AR15006001800

Norm 20 stationary shelving



Stationary shelving set norm 20 with louvred shelf – height 2000 mm

Width mm	For upright depth 300 mm	For upright depth 400 mm	For upright depth 500 mm	For upright depth 600 mm
	Product code	Product code	Product code	Product code
600	N20AR6003002000	N20AR6004002000	N20AR6005002000	N20AR6006002000
700	N20AR7003002000	N20AR7004002000	N20AR7005002000	N20AR7006002000
800	N20AR8003002000	N20AR8004002000	N20AR8005002000	N20AR8006002000
900	N20AR9003002000	N20AR9004002000	N20AR9005002000	N20AR9006002000
1000	N20AR10003002000	N20AR10004002000	N20AR10005002000	N20AR10006002000
1200	N20AR12003002000	N20AR12004002000	N20AR12005002000	N20AR12006002000
1300	N20AR13003002000	N20AR13004002000	N20AR13005002000	N20AR13006002000
1400	N20AR14003002000	N20AR14004002000	N20AR14005002000	N20AR14006002000
1500	N20AR15003002000	N20AR15004002000	N20AR15005002000	N20AR15006002000



Norm 20 shelving unit elements



Norm 20 upright – max. section load 600 kg

- Aluminium
- Pitch 150 mm

Height mm	For upright depth 300 mm	For upright depth 400 mm	For upright depth 500 mm	For upright depth 600 mm
	Product code	Product code	Product code	Product code
1200	0201007	0201017	0201037	0201047
1400	0201077	0201087	0201107	0201117
1600	0201147	0201157	0201177	0201187
1800	0201217	0201227	0201247	0201257
2000	0201287	0201297	0201317	0201327



Norm 20 upright – max. section load 1200 kg

- Aluminium
- Pitch 150 mm



Height mm	For upright depth 400 mm	For upright depth 500 mm	For upright depth 600 mm
	Product code	Product code	Product code
1800	0201225	0201245	0201255
2000	0201295	0201315	0201325

Norm 20 stationary shelving



Norm 20 solid shelf

- Aluminium

Width mm	For upright depth 300 mm	For upright depth 400 mm	For upright depth 500 mm	For upright depth 600 mm
	Product code	Product code	Product code	Product code
600	0202432	0202442	0202462	0202472
700	0202522	0202552	0202562	0202592
800	0202502	0202512	0202532	0202542
900	0202572	0202582	0202602	0202612
1000	0202642	0202652	0202672	0202682
1100	0202452	0202482	0202632	0202662
1200	0202712	0202722	0202742	0202752
1300	0202762	0202772	0202802	0202832
1400	0202783	0202793	0202813	0202823
1500	0202853	0202863	0202883	0202893



Norm 20 louvred shelf

- Shelf load: 200 kg
- Width: 600 mm
- Aluminium

Width mm	For upright depth 300 mm	For upright depth 400 mm	For upright depth 500 mm	For upright depth 600 mm
	Product code	Product code	Product code	Product code
600	0201532	0201542	0201562	0201572
700	0201522	0201552	0201582	0201592
800	0201602	0201612	0201632	0201642
900	0201672	0201682	0201702	0201712
1000	0201742	0201752	0201772	0201782
1200	0201812	0201822	0201842	0201852
1300	0201862	0201872	0201902	0201932
1400	0201882	0201892	0201912	0201922
1500	0201952	0201962	0201982	0201992



ottle shelf

- Polymer-coated stainless steel
- Not for corner extension
- Silver grey
- Capacity for 0.75/1 litre bottles
- est. units per row in combination 11



Width mm	For upright depth 500 mm	Product code
800		0104072
1000		0104082



ox storage shelf

- Bay load: 100 kg
- Width: 1000 mm
- Capacity up to 3 boxes upright
- Corner extension not possible



	Dimensions W × D × H mm	Product code
A-KA/N5 1000/500	1000 × 440 × 109	0104052



Norm 20 cross brace

- Requires 1 in every 3rd section
- Suitable for all shelf widths and uprights



	Dimensions W × D × H mm	Product code
RG-KV/N5/12/20/25	1009 × 48 × 934	0103072

Norm 20 stationary shelving



Norm 20 cross brace for back-to-back assembly

- Fixing straps incl. 4 screws and nuts
- An additional cross brace is required for assembly.
- Stainless steel

	Dimensions W × D × H mm	Product code
LaSet-RR 61/30/12	96 × 61 × 90	0115732



Push-through protection for uprights

- maximum safety
- Effortless hooking in and removal
- space-saving
- electropolished
- hard-wearing



Height mm	For upright depth 500 mm	For upright depth 600 mm
	Product code	Product code
1800	0204104	0204105
2000	0204106	0204107



Push-through protection for shelves

- For attachment between two uprights on the broadside of a shelf
- Height: 130 mm
- Electropolished stainless steel



Width mm	Product code
700	0117418
800	0117412
900	0117413
1000	0117414
1200	0117415
1300	0117419
1400	0117416



Push-through protection

- Electropolished stainless steel
- For side attachment

Depth mm	Product code
500	0117402
600	0117403



Bracing bar

- Aluminium
- As an alternative to the cross brace for loading the shelf from both sides
- With assembly accessories
- 4 long rails required per section



Width mm	Product code
600	0217022
700	0217029
800	0217023
900	0217024
1000	0217025
1200	0217026
1300	0217030
1400	0217027



Corner hook

- For corner connections
- For louvred shelves and solid shelves



	Dimensions W × D × H mm	Product code
RG-EVK N5/20/25	46 × 22 × 64	0203126

Norm 20 stationary shelving



Double corner hook for hook rail

- For corner connections
- For louvred shelves and solid shelves

RG-EVK N20 GHS	Product code 0211056
----------------	--------------------------------



Shelf divider

- Stainless steel
- For enclosed systems

	For upright depth 500 mm	For upright depth 600 mm
Height mm	Product code	Product code
210	7504221	7504220



Shelf railing

- Stainless steel
- To stop items falling out of the front or back
- With plastic end caps

Width mm	Product code
600	0115242
700	0115241
800	0115243
900	0115244
1000	0115245
1200	0115246
1300	0115249
1400	0115247
1500	0115248



Shelf railing holder

- Stainless steel
- Infinitely height-adjustable.
- For use with shelf railing



	Dimensions W × D × H mm	Product code
RG-SLH	42 × 30 × 60	0115252



Weight distribution plate

- Aluminium



	Dimensions W × D × H mm	Product code
BVP/N20 115/115/6	115 × 115 × 6	0203142



Hanging rail support

- Aluminium
- For attaching hanging rails
- Also for securing stored items from the sides



For upright depth 300 mm	For upright depth 400 mm	For upright depth 500 mm	For upright depth 600 mm
Product code 0221862	Product code 0221872	Product code 0221892	Product code 0221902

Norm 20 stationary shelving



Hanging rail

- Aluminium
- For hanging between two uprights
- For attaching hooks
- Universal rail 45 x 10 mm

Width mm	Product code
600	0203162
700	0203232
800	0203172
900	0203182
1000	0203192
1200	0203202
1300	0203242
1400	0203212



Ceiling or floor fixing attachment

- Stainless steel
- For additional securing of shelves.
- Without fixing material



	Dimensions W × D × H mm	Product code
RG-DBBF/N5/12/20/25/28	70 × 29 × 202	0103152



Wall mounting

- Stainless steel
- For upright



	Dimensions W × D × H mm	Product code
BFSchr DIN 571 A2 Ø5x50	5 × 50	0116038
BFSchr DIN 571 A2 Ø5x40	5 × 40	0116037
RG-WBF/N12/20	77 × 40 × 18	0116036



Wallfixing

- Stainless steel
- For uprights used against walls with coving.
- For 25 x 25 mm tube
- Without fixing material



	Dimensions W × D × H mm	Product code
RG-HWBF/N5	85 × 68 × 58	0116031



Dunnage rack

- Aluminium
- For self-assembly



Width mm	For upright depth 500 mm	For upright depth 600 mm
	Product code	Product code
1000	0203422	0203442
1200	0203412	0203432



Norm 20 reinforcing beam

- high-quality stainless steel
- easy assembly
- Optimum distribution of the weight
- Increased weight capacity of the shelf



Depth mm	Product code
300	0102099
400	0102100
500	0102101
600	0102102

Norm 12 stationary shelving

The special material mix of aluminium and plastic makes this shelving system an equally versatile attractive alternative, for example for the storage of pharmacy goods.



SHELVING SYSTEMS

03



Stationary shelving set norm 12 with solid shelf



Stationary shelving set norm 12 with solid shelf – height 1200 mm

Width mm	For upright depth 400 mm	For upright depth 500 mm	For upright depth 600 mm
	Product code	Product code	Product code
600	N12GS6004001200	N12GS6005001200	N12GS6006001200
800	N12GS8004001200	N12GS8005001200	N12GS8006001200
900	N12GS9004001200	N12GS9005001200	N12GS9006001200
1000	N12GS10004001200	N12GS10005001200	N12GS10006001200
1100	N12GS11004001200	N12GS11005001200	N12GS11006001200
1200	N12GS12004001200	N12GS12005001200	N12GS12006001200
1300	N12GS13004001200	N12GS13005001200	N12GS13006001200
1400	N12GS14004001200	N12GS14005001200	N12GS14006001200
1500	N12GS15004001200	N12GS15005001200	N12GS15006001200



Stationary shelving set norm 12 with solid shelf – height 1400 mm

Width mm	For upright depth 400 mm	For upright depth 500 mm	For upright depth 600 mm
	Product code	Product code	Product code
600	N12GS6004001400	N12GS6005001400	N12GS6006001400
800	N12GS8004001400	N12GS8005001400	N12GS8006001400
900	N12GS9004001400	N12GS9005001400	N12GS9006001400
1000	N12GS10004001400	N12GS10005001400	N12GS10006001400
1100	N12GS11004001400	N12GS11005001400	N12GS11006001400
1200	N12GS12004001400	N12GS12005001400	N12GS12006001400
1300	N12GS13004001400	N12GS13005001400	N12GS13006001400
1400	N12GS14004001400	N12GS14005001400	N12GS14006001400
1500	N12GS15004001400	N12GS15005001400	N12GS15006001400

Norm 12 stationary shelving



Stationary shelving set norm 12 with solid shelf – height 1600 mm

Width mm	For upright depth 400 mm	For upright depth 500 mm	For upright depth 600 mm
	Product code	Product code	Product code
600	N12GS6004001600	N12GS6005001600	N12GS6006001600
800	N12GS8004001600	N12GS8005001600	N12GS8006001600
900	N12GS9004001600	N12GS9005001600	N12GS9006001600
1000	N12GS10004001600	N12GS10005001600	N12GS10006001600
1100	N12GS11004001600	N12GS11005001600	N12GS11006001600
1200	N12GS12004001600	N12GS12005001600	N12GS12006001600
1300	N12GS13004001600	N12GS13005001600	N12GS13006001600
1400	N12GS14004001600	N12GS14005001600	N12GS14006001600
1500	N12GS15004001600	N12GS15005001600	N12GS15006001600



Stationary shelving set norm 12 with solid shelf – height 1800 mm

Width mm	For upright depth 400 mm	For upright depth 500 mm	For upright depth 600 mm
	Product code	Product code	Product code
600	N12GS6004001800	N12GS6005001800	N12GS6006001800
800	N12GS8004001800	N12GS8005001800	N12GS8006001800
900	N12GS9004001800	N12GS9005001800	N12GS9006001800
1000	N12GS10004001800	N12GS10005001800	N12GS10006001800
1100	N12GS11004001800	N12GS11005001800	N12GS11006001800
1200	N12GS12004001800	N12GS12005001800	N12GS12006001800
1300	N12GS13004001800	N12GS13005001800	N12GS13006001800
1400	N12GS14004001800	N12GS14005001800	N12GS14006001800
1500	N12GS15004001800	N12GS15005001800	N12GS15006001800



Stationary shelving set norm 12 with solid shelf – height 2000 mm

Width mm	For upright depth 400 mm	For upright depth 500 mm	For upright depth 600 mm
	Product code	Product code	Product code
600	N12GS6004002000	N12GS6005002000	N12GS6006002000
800	N12GS8004002000	N12GS8005002000	N12GS8006002000
900	N12GS9004002000	N12GS9005002000	N12GS9006002000
1000	N12GS10004002000	N12GS10005002000	N12GS10006002000
1100	N12GS11004002000	N12GS11005002000	N12GS11006002000
1200	N12GS12004002000	N12GS12005002000	N12GS12006002000
1300	N12GS13004002000	N12GS13005002000	N12GS13006002000
1400	N12GS14004002000	N12GS14005002000	N12GS14006002000
1500	N12GS15004002000	N12GS15005002000	N12GS15006002000



Norm 12 stationary shelving

Stationary shelving set norm 12 with louvred shelf



Stationary shelving set norm 12 with louvred shelf – height 1200 mm

Width mm	For upright depth 400 mm	For upright depth 500 mm	For upright depth 600 mm
	Product code	Product code	Product code
600	N12KR6004001200	N12KR6005001200	N12KR6006001200
800	N12KR8004001200	N12KR8005001200	N12KR8006001200
900	N12KR9004001200	N12KR9005001200	N12KR9006001200
1000	N12KR10004001200	N12KR10005001200	N12KR10006001200
1100	N12KR11004001200	N12KR11005001200	N12KR11006001200
1200	N12KR12004001200	N12KR12005001200	N12KR12006001200
1300	N12KR13004001200	N12KR13005001200	N12KR13006001200
1400	N12KR14004001200	N12KR14005001200	N12KR14006001200
1500	N12KR15004001200	N12KR15005001200	N12KR15006001200



Stationary shelving set norm 12 with louvred shelf – height 1400 mm

Width mm	For upright depth 400 mm	For upright depth 500 mm	For upright depth 600 mm
	Product code	Product code	Product code
600	N12KR6004001400	N12KR6005001400	N12KR6006001400
800	N12KR8004001400	N12KR8005001400	N12KR8006001400
900	N12KR9004001400	N12KR9005001400	N12KR9006001400
1000	N12KR10004001400	N12KR10005001400	N12KR10006001400
1100	N12KR11004001400	N12KR11005001400	N12KR11006001400
1200	N12KR12004001400	N12KR12005001400	N12KR12006001400
1300	N12KR13004001400	N12KR13005001400	N12KR13006001400
1400	N12KR14004001400	N12KR14005001400	N12KR14006001400
1500	N12KR15004001400	N12KR15005001400	N12KR15006001400



Stationary shelving set norm 12 with louvred shelf – height 1600 mm

Width mm	For upright depth 400 mm	For upright depth 500 mm	For upright depth 600 mm
	Product code	Product code	Product code
600	N12KR6004001600	N12KR6005001600	N12KR6006001600
800	N12KR8004001600	N12KR8005001600	N12KR8006001600
900	N12KR9004001600	N12KR9005001600	N12KR9006001600
1000	N12KR10004001600	N12KR10005001600	N12KR10006001600
1100	N12KR11004001600	N12KR11005001600	N12KR11006001600
1200	N12KR12004001600	N12KR12005001600	N12KR12006001600
1300	N12KR13004001600	N12KR13005001600	N12KR13006001600
1400	N12KR14004001600	N12KR14005001600	N12KR14006001600
1500	N12KR15004001600	N12KR15005001600	N12KR15006001600



Stationary shelving set norm 12 with louvred shelf – height 1800 mm

Width mm	For upright depth 400 mm	For upright depth 500 mm	For upright depth 600 mm
	Product code	Product code	Product code
600	N12KR6004001800	N12KR6005001800	N12KR6006001800
800	N12KR8004001800	N12KR8005001800	N12KR8006001800
900	N12KR9004001800	N12KR9005001800	N12KR9006001800
1000	N12KR10004001800	N12KR10005001800	N12KR10006001800
1100	N12KR11004001800	N12KR11005001800	N12KR11006001800
1200	N12KR12004001800	N12KR12005001800	N12KR12006001800
1300	N12KR13004001800	N12KR13005001800	N12KR13006001800
1400	N12KR14004001800	N12KR14005001800	N12KR14006001800
1500	N12KR15004001800	N12KR15005001800	N12KR15006001800

Norm 12 stationary shelving



Stationary shelving set norm 12 with louvred shelf – height 2000 mm

Width mm	For upright depth 400 mm	For upright depth 500 mm	For upright depth 600 mm
	Product code	Product code	Product code
600	N12KR6004002000	N12KR6005002000	N12KR6006002000
800	N12KR8004002000	N12KR8005002000	N12KR8006002000
900	N12KR9004002000	N12KR9005002000	N12KR9006002000
1000	N12KR10004002000	N12KR10005002000	N12KR10006002000
1100	N12KR11004002000	N12KR11005002000	N12KR11006002000
1200	N12KR12004002000	N12KR12005002000	N12KR12006002000
1300	N12KR13004002000	N12KR13005002000	N12KR13006002000
1400	N12KR14004002000	N12KR14005002000	N12KR14006002000
1500	N12KR15004002000	N12KR15005002000	N12KR15006002000



Norm 12 shelving unit elements



Norm 12 upright

- Aluminium
- Pitch 150 mm

Height mm	For upright depth 400 mm	For upright depth 500 mm	For upright depth 600 mm
	Product code	Product code	Product code
1200	0201017	0201037	0201047
1400	0201087	0201107	0201117
1600	0201157	0201177	0201187
1800	0201227	0201247	0201257
2000	0201297	0201317	0201327



Norm 12 solid shelf

- Dishwasher suitable
- perfect hygiene
- high weight capacity
- easy handling

Width mm	For upright depth 400 mm	For upright depth 500 mm	For upright depth 600 mm
	Product code	Product code	Product code
600	0602449	0602469	0602479
800	0602519	0602539	0602549
900	0602589	0602609	0602619
1000	0602659	0602679	0602689
1100	0602719	0602739	0602769
1200	0602729	0602749	0602759
1300	0602349	0602369	0602379
1400	0602799	0602819	0602829
1500	0602869	0602889	0602899

Norm 12 stationary shelving



Norm 12 louvred shelf

- Dishwasher suitable
- Well ventilated storage
- perfect hygiene
- high weight capacity
- easy handling

Width mm	For upright depth 400 mm	For upright depth 500 mm	For upright depth 600 mm
	Product code	Product code	Product code
600	0601549	0601569	0601579
800	0601619	0601639	0601649
900	0601689	0601709	0601719
1000	0601759	0601779	0601789
1100	0601449	0601469	0601479
1200	0601829	0601849	0601859
1300	0601349	0601369	0601379
1400	0601899	0601919	0601929
1500	0601969	0601989	0601999



Norm 12 cross brace

- Requires 1 in every 3rd section
- Suitable for all shelf widths and uprights



	Dimensions W × D × H mm	Product code
RG-KV/N5/12/20/25	1009 × 48 × 934	0103072



Norm 12 cross brace for back-to-back assembly

- Fixing straps incl. 4 screws and nuts
- An additional cross brace is required for assembly.
- Stainless steel



	Dimensions W × D × H mm	Product code
LaSet-RR 61/30/12	96 × 61 × 90	0115732



Push-through protection for uprights

- maximum safety
- Effortless hooking in and removal
- space-saving
- electropolished
- hard-wearing



Height mm	For upright depth	For upright depth
	500 mm	600 mm
	Product code	Product code
1800	0204104	0204105
2000	0204106	0204107



Push-through protection for shelves

- For attachment between two uprights on the broadside of a shelf
- Height: 130 mm
- Electropolished stainless steel



Width mm	Product code
600	0117411
1500	0117417



Push-through protection

- Electropolished stainless steel
- For side attachment



Depth mm	Product code
600	0117403
500	0117402

Norm 12 stationary shelving



Corner hook

- For solid and louvred shelves
- Polymer

RG-EVK N12/28	Product code 0603139
---------------	---------------------------------------



Easy Rider systems

Easy Rider systems

The Easy Rider system is the ideal solution for when storage capacity has to be increased but space is limited. Because the Easy Rider system eliminates the need for redundant aisles, this system can increase the capacity of storage rooms by up to 100 percent compared to conventional shelving systems.

All Hupfer Norm shelving units can also be attached for storing a wide variety of goods. The Hupfer **Easy Rider systems for containers or baskets**, alongside their insertion systems, are specially designed for efficient, space-saving storage of containers or Hupfer sterile goods baskets in StU and ISO formats.



**UP TO 100%
MORE STORAGE
SPACE**

Easy Rider system

Stationary shelving system

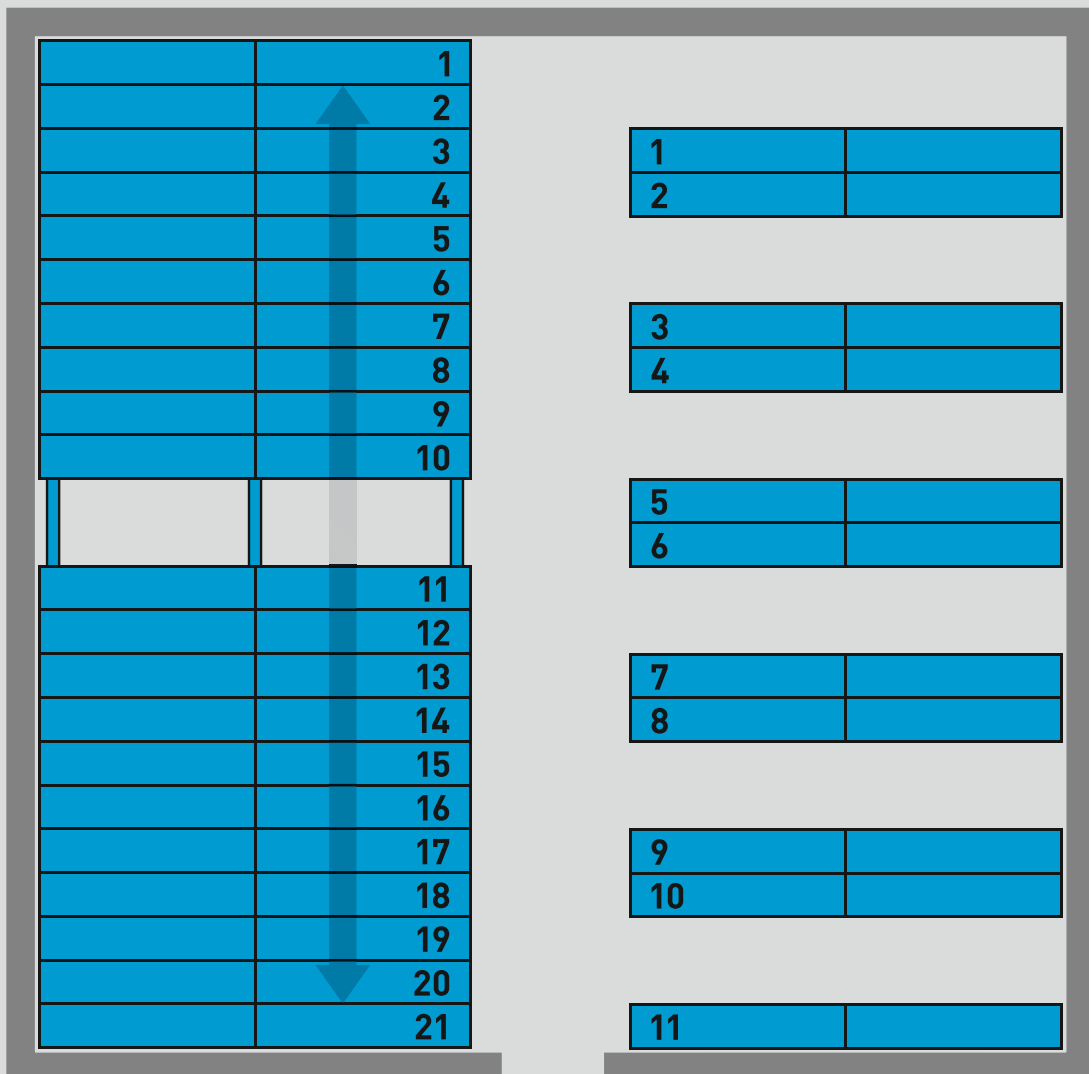

Comparison of a conventional, fixed storage system with a Hupfer Easy Rider sliding system. In an ideal case, the utilisation of storage space is up to 100% higher.

Easy Rider systems

Easy Rider systems



TopRail Easy Rider systems

- Height: 2085 mm
- 100% more shelf space
- Ground clearance when cleaning the premises
- perfect hygiene
- high weight capacity



	Dimensions W × D × H mm	Product code
SRG-TOP N5 13965/2636/2085 - CS2-3	13965 × 2636 × 2085	7506120
SRG-TOP N5 4105/2636/2085 - CS2-2	4105 × 2636 × 2085	7506119
SRG-TOP N5 6161/5177/2085 - CS3-1	6161 × 5177 × 2085	7506121
SRG-TOP N5 6465/3911/2085 - CS3-2	6465 × 3911 × 2085	7506122
SRG-TOP N5 7605/2636/2085 - CS2-1	7605 × 2636 × 2085	7506118



Easy Rider floor rail – height 17 mm

- For Easy Rider system
- Variable length
- Costs per metre



	Dimensions W × D × H mm	Product code
SRG-BS H17		0120810
SRG-BS H17 - 1000 mm	159 × 19 × 1000	0120814
SRG-BS H17 - 1500 mm	159 × 19 × 1500	0120815
SRG-BS H17 - 2500 mm	159 × 19 × 2500	0120816



Easy Rider floor rail – height 23 mm

- For Easy Rider system
- Variable length
- Costs per metre



	Dimensions W × D × H mm	Product code
SRG-BS H23		0120910
SRG-BS H23 - 1000 mm	83 × 23 × 1000	0120914
SRG-BS H23 - 1500 mm	83 × 23 × 1500	0120915
SRG-BS H23 - 2500 mm	83 × 23 × 2500	0120916



Easy Rider stop

- For Easy Rider floor rails
- With end plate



	Dimensions W × D × H mm	Product code
SRG-BS/EA H17	160 × 72 × 28	0120922
SRG-BS/EA H23	86 × 72 × 25	0120917



Easy Rider foot brake

- Undisturbed operation of the shelf
- arbitrary positioning
- Can be retrofitted at any time
- easy assembly
- high weight capacity



	Dimensions W × D × H mm	Product code
SRG-FS 210/75/53	638 × 237 × 123	0120811



Easy Rider cross brace for roller chassis

- Stability and torsional rigidity
- Suitable for different shelf widths
- Sustainability
- perfect hygiene
- high weight capacity



	Dimensions W × D × H mm	Product code
SRG-KV LW 600		0120943
SRG-KV LW 800-1500	960 × 34 × 546	0120942

Easy Rider systems



Easy Rider roller chassis

- for Easy Rider sliding shelving system
- for effortless shifting
- high quality and durable
- 0



	Dimensions W × D × H mm	Product code
SRG-LW/Medidul 1200/au	1244 × 86 × 70	7505502
SRG-LW 1200	1252 × 86 × 105	0120982
SRG-LW/Medidul 1200/mi	1252 × 93 × 105	7505504
SRG-LW 600	638 × 86 × 105	0120932
SRG-LW/Medidul 600/au	638 × 86 × 105	7504395
SRG-LW/Medidul 600/mi	638 × 93 × 105	7504396



Crossbar set for 3 StU

- for Easy Rider sliding shelving system
- For assembly on roller chassis
- made of high quality stainless steel



	Dimensions W × D × H mm	Product code
T-SET-MEDIDUL/2x3StE-R/R		7505503
T-SET-MEDIDUL/4StE	1255 × 70 × 55	7505514
T-SET-MEDIDUL/2StE	597 × 55 × 90	7505515
T-SET-MEDIDUL/3StE	927 × 55 × 90	7504397



Mobile shelving



Mobile shelving

Hupfer mobile shelving units combine two essential logistics functions: storage and transport. This means working material can be stored in large quantities but are always flexibly available where they are needed. Simpler work processes reduce the number of repacking operations and increase efficiency, economy and ergonomics.

With a wide selection of open and solid shelves, mobile shelving can be easily adapted to whatever items are stored on them. Smooth-running castors and practical total locks make them easy and safe to handle, even when carrying large quantities of stored items.



Transport shelving unit



Transport shelving unit – height 900 mm

- In kit form
- For self-assembly
- Not including shelves
- Pitch: 150 mm



Width mm	For upright depth 500 mm	For upright depth 600 mm
	Product code	Product code
1000	0121390	0121391
1200	0121392	0121393
1300	0121414	0121415
1400	0121394	0121395



Transport shelving unit – height 1200 mm

- In kit form
- For self-assembly
- Not including shelves
- Pitch: 150 mm



Width mm	For upright depth 500 mm	For upright depth 600 mm
	Product code	Product code
1000	0121403	0121404
1200	0121405	0121406
1300	0121416	0121417
1400	0121409	0121410

Mobile shelving



Transport shelving unit – height 1652 mm

- In kit form
- For self-assembly
- Not including shelves
- Pitch: 150 mm



Width mm	For upright depth 500 mm	For upright depth 600 mm
	Product code	Product code
1000	0123092	0123093
1200	0123094	0123095
1300	0121418	0121419
1400	0123096	0123097



Accessories for transport shelving unit



Norm 5 solid shelf for RTW/Z

- easy to clean
- perfect hygiene
- high weight capacity
- easy handling



Width mm	For upright depth 500 mm	For upright depth 600 mm
	Product code	Product code
1000	0102672	0102682
1200	0102742	0102752
1300	0101932	0101942
1400	0102812	0102822



Norm 5 louvred shelf for RTW/Z

- Stainless steel
- Bay load: 150 kg



Width mm	For upright depth 500 mm	For upright depth 600 mm
	Product code	Product code
1000	0101777	0101787
1200	0101847	0101857
1400	0101917	0101927

Mobile shelving



Norm 5 wired shelf for RTW/Z

- Well ventilated storage
- perfect hygiene
- high weight capacity
- easy handling

Width mm	For upright depth 500 mm	For upright depth 600 mm
	Product code	Product code
1000	0101772	0101782
1200	0101842	0101852
1300	0101932	0101942
1400	0101912	0101922

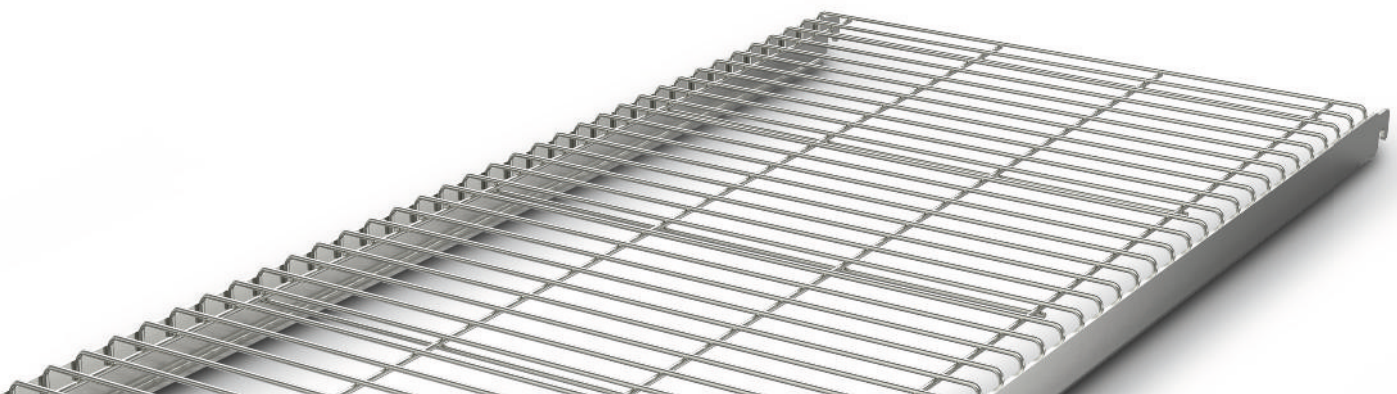



Wall shelving

Wall shelving

Where there is not enough space for standing units, wall shelving from Hupfer offers practical storage space within easy reach so that working material is available wherever it is needed.

Both the length of the adjustable rails and the width, depth and type of shelves can be widely varied. This means the wall shelving can be adapted to requirements, without tools, for efficient work and flexibility.

Hupfer wall shelving is robust, can hold heavy loads and supports a wide variety of work processes without taking up additional space. Work material can be stored directly on the shelves or in wire baskets, always clearly arranged and in easy reach.

Carefully welded edges and sturdy surfaces guarantee easy cleaning and prevent damage to sensitive materials.





Wall shelving

Wall shelving elements



Wall shelf rail

- For attaching brackets
- Depth: 25 mm
- Pitch: 75 mm
- 4 drill holes in the wall required



INOX
ATMANSI ERN ATTEPI

	Dimensions W × D × H mm	Product code
WB VeS 60/25/1200	60 × 25 × 1200	0163433
WB VeS 60/25/740	60 × 25 × 740	0163432



Bracket for solid wall shelf

- For solid wall shelves
- For attaching to adjustable rails
- Stainless steel



INOX
ATMANSI ERN ATTEPI

	Dimensions W × D × H mm	Product code
WB KON 300	294 × 42 × 144	0163434
WB KON 400	394 × 42 × 144	0163435



Bracket for solid wall shelf – wall mounting

- For solid wall shelves
- For direct wall mounting
- Stainless steel



INOX
ATMANSI ERN ATTEPI

	Dimensions W × D × H mm	Product code
WB KON-WB 300	280 × 42 × 144	0163436
WB KON-WB 400	380 × 42 × 144	0163437



Bracket for Norm 5 and Norm 20 shelf

- For Norm 5 and Norm 20 shelves
- For attaching to adjustable rails
- Electropolished stainless steel

	Dimensions W × D × H mm	Product code
WB KON N5/20 300	299 × 42 × 199	0163461
WB KON N5/20 400	399 × 42 × 203	0163462



Bracket for pipe shelf

- For tubular shelves
- For attaching to adjustable rails
- Stainless steel

	Dimensions W × D × H mm	Product code
WB KON 4RA 300 mi	312 × 42 × 103	0163464
WB KON 4RA 300 li	314 × 42 × 103	0163463
WB KON 4RA 300 re	314 × 42 × 103	0163465
WB KON 5RA 400 mi	412 × 42 × 103	0163467
WB KON 5RA 400 re	414 × 42 × 103	0163468
WB KON 5RA 400 li	414 × 42 × 103	0163466



Solid wall shelf

- With 40 mm upstand on the rear
- Stainless steel

Width mm	For upright depth 300 mm	For upright depth 400 mm
	Product code	Product code
600	0163422	0163427
800	0163423	0163428
1000	0163424	0163429
1200	0163425	0163430
1400	0163426	0163431

Hupfer medical furnishings and fixtures are characterised by their high-quality workmanship, flexibility and extreme resilience in tough conditions. MediFurn is a new generation of furnishings that sets new standards in terms of functionality, workmanship and design. The seamlessly welded products are easier to clean and hygiene can be more reliably maintained.



MediFurn



Added hygiene: bodies with HS, H1 and H2 quality

As well as products designed to the familiar HS hygienic standard, bodies with the optimised hygienic design types H1 and H2 as per DIN 18865-9 are now available.

The new models are characterised by a fully-welded finish, with corners rounded to various spherical radii. The key benefit of seamless design is that there are no longer any gaps that secretions, blood, proteins or other liquids might penetrate.



HYGIENE STUFE H2

For **hygienic level H2**, the bases and side panels of the bodies have a seamless welded design with a spherical radius of around 20 mm on the inside. This extra large radius is ideal for particularly thorough cleaning and significantly reduces the risk of germs. H2 bodies thus also offer maximum safety in places where maintaining hygiene is particularly challenging.

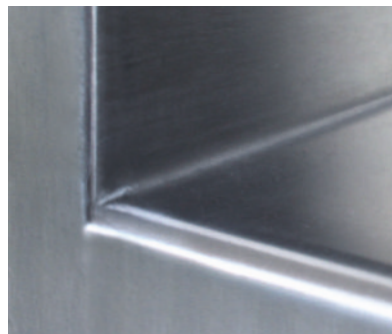

HYGIENE STUFE H1

For **hygiene level H1**, the bases and side panels of the bodies are also seamlessly welded, with a smaller spherical radius of around 3 mm on the inside. H1 bodies are recommended for areas with low to moderate hygiene requirements.



HYGIENE STUFE HS

Hygiene level HS is still the standard that is most commonly used. Bodies manufactured in compliance with this standard still have seams between the base and side panels, making intensive cleaning more difficult. HS bodies are therefore only suitable for areas where hygiene is not critical.



**The quickest fix:
plinth with magnetic lock**

The 100 mm base is secured to the floor frame with a magnetic catch and the joint can be sealed on site with silicone if necessary. This means the base can be quickly removed for maintenance.



**Safe and strong:
welded shelving bolts**

All shelving bolts sit flush so that there are no hard-to-reach recesses, thus guaranteeing high cleaning standards.

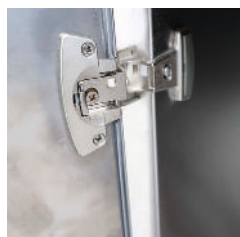

**Easy to clean:
the hinges**

The low installation height and the large opening angle of the hinge allow easy and trouble-free access to the inside of the cabinet. In addition, the hinge can be fitted to the cabinet without tools.

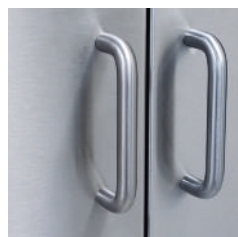

**Top-class protection
recessed handles**

The handles in the drawers, runners and cabinet doors are all inside the contour of the worktop, helping to prevent collisions when passing.

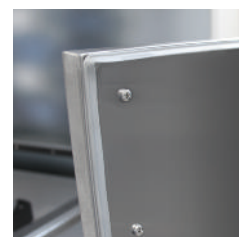

**Universal safety:
sealing lips**

The continuous seals on runners and doors stop liquids and dust from getting in.



MediFurn

MediFurn cleaning table systems

Cleaning tables are subject to particularly challenging hygiene conditions. To optimise hygienic safety, we equip the bodies of the MediFurn cleaning table systems to meet hygiene levels H1 and H2 on request. The seamless design avoids dirt-prone recesses, so that cleaning is easier.

The **individual modules** (sink module, cabinet with doors, drawers, etc.) are available in various sizes and designs as required.

Our cleaning table systems are also available with optional **accessories**, such as air jets, spray attachments, spray guards and ultrasonic baths.



*Our cleaning table systems are also available with optional **accessories**, such as air jets, spray attachments, spray guards and ultrasonic baths.*



Wells are available in a range of designs and sizes, and sit seamlessly in the work surface.

Limitless options for a all-round safety.

The modular design of MediFurn furnishings means cleaning table systems can be created in any conceivable shape and size. They optimally combine high standards of functionality and ergonomic design. Precision manufacturing and smart solutions down to the finest detail guarantee easy cleaning and safety up to hygiene level H2.

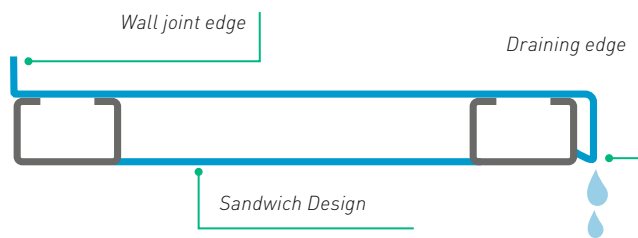

Beaded edging and draining edge

The beaded edging stops liquids dripping from worktop while the draining edge reduces the risk of liquids penetrating the inside of the cabinet. Continuous sealing lips on the doors and runners provide additional protection.

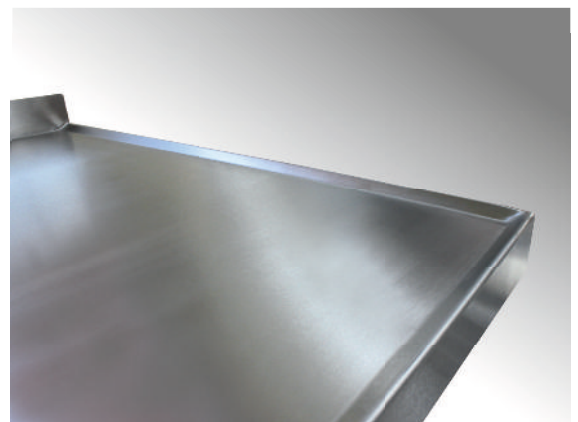

Effective beaded edging: Stops liquids from dripping off the worktop.

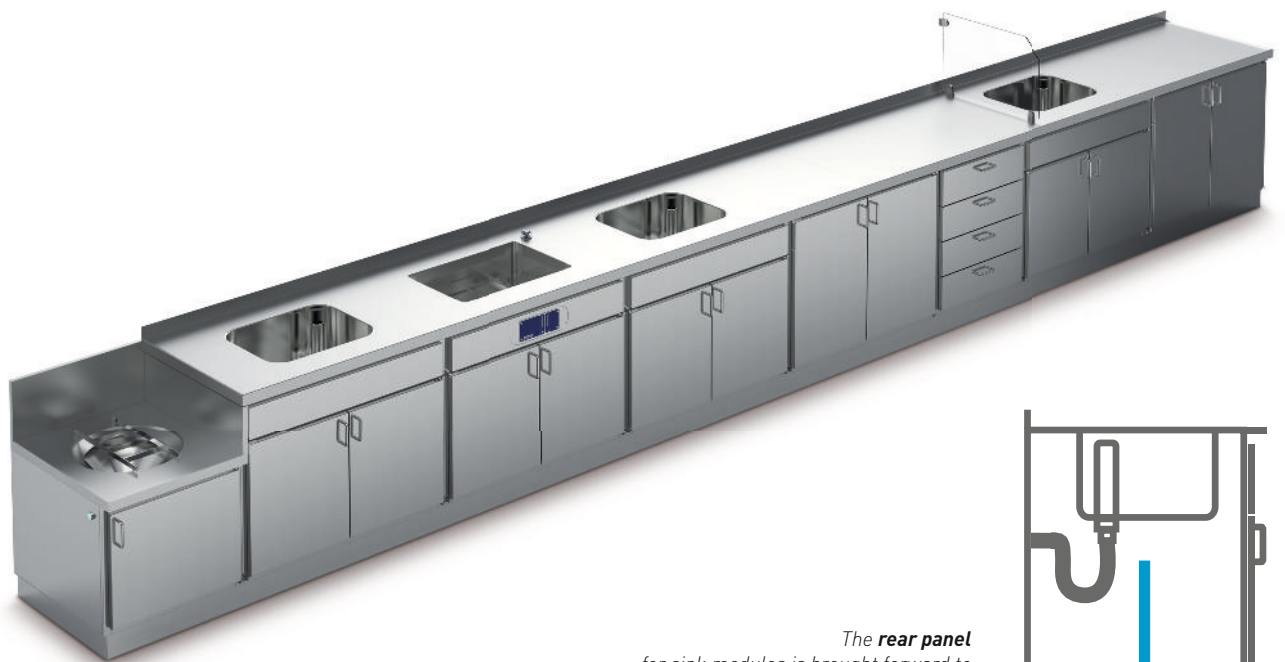

*The **rear panel** for sink modules is brought forward to protect any installations behind it and **can be removed for inspection.***

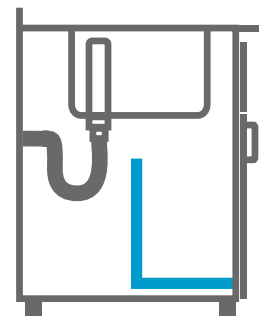

MediFurn

MediFurn packing tables

Checking, sorting, cleaning, packaging – packing tables bring together a range of jobs at a single workstation. This means they have very high requirements for safe, functional and ergonomic technical equipment.

MediFurn packing tables are made completely of premium quality stainless steel and are designed to be easily adapted to the needs of individual employees.

The tables offer maximum flexibility for connection to existing building services while height-adjustable tables can be set to the ideal working height at the touch of a button. All the technical components are arranged within easy reach.

On request, MediFurn packing tables are also available as mobile versions with casters.

If additional working space is required, the tray pull-out is the optimum solution, and slides back under the worktop when not in use.





Energy-efficient LED technology and high-luminosity cold-light fluorescent tubes are available to illuminate the workplace.



The connection to the on-site compressed air, electricity and network outlets is made via the central utility column which optionally reaches to the ceiling. The connections can be accessed at any time via the inspection flap.



The working height can be precisely adjusted by up to 300 mm at the touch of a button on the digital display. The standard initial heights are 750 mm and 850 mm.



The PC cabinet with a fully extendable pull-out runner has wing doors with vents to ensure the circulation of air around computers and other equipment prone to heating up.



To avoid cable clutter, all connecting lines and cables can be routed along the trough over almost the entire width.



Drawer blocks, drawers for stainless steel containers and fully extendable pull-out drawers are available for the base structure. Self-closing and wing doors are optionally available.

Medical furnishings

MediFurn tall cabinets and wall cabinets

MediFurn tall cabinets and wall cabinets offer space for protected storage and guarantee organisation, versatility and easy handling at the same time. They are carefully tailored to a wide array of storage items and provide a quick and secure access to material and instruments.

They are designed to hold solid or wired shelves and can be alternatively equipped with polymer walls in StU or ISO format to store modular or sterile goods baskets.



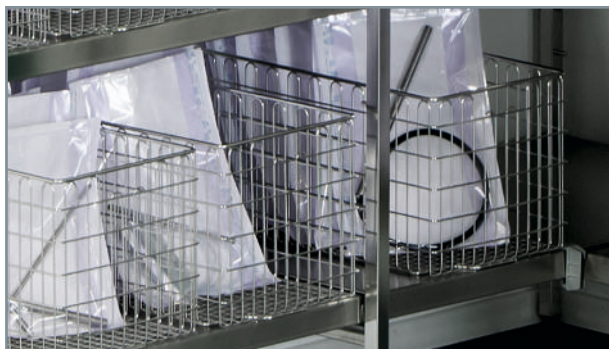

Solid or wired shelves can be used to store a variety of items.



Internal polymer panels in ISO format are available as an option for storing modular and sterile goods baskets, making it even easier to handle items.



Panels, inclined tops and flat tops ensure visually tidy connections all round to stop dust from collecting and to make the cabinets easier to clean.



Drawers in a range of sizes can be integrated as required.



The **pharmacy cabinet** is specially designed to provide safe storage for instruments. It can be easily pulled out to provide a perfect overview of everything inside. Holders are available for a wide range of instruments.



Depending on the application, the **cabinet modules** can be fitted with Medidul sections for **StU or ISO** to hold sterile goods basket and containers.

Medical furnishings

Packing and work tables

Hupfer packing and work tables help operational processes by providing space to work. The table frames are completely made of stainless steel. Many models come either with height-adjustable screw feet or in a mobile version with castors. Robust, easy-to-clean tabletops and intermediate shelves extend the range of uses even further.

Tops and bases in StU or ISO sizes can be individually equipped with baskets, shelves and many other accessories. This means that important work equipment is clearly sorted and within easy reach at all times. Utility columns are available for electricity and compressed air supplies.



Ergonomics at the touch of a button

The electrohydraulic height adjustment allows the working height to be adjusted to anywhere between 850 and 1150 mm. The powerful 230-volt electric motor is protected in the cabinet under the worktop so that installations are neither visible nor get in the way.

The base can optionally be equipped with a solid shelf, a louvred shelf or a wired shelf from the Norm 5 shelving system.



Packing and work tables



Stationary packing tables

Sturdy, versatile and expandable, packing tables can be used in many different departments. The electrohydraulic height adjustment makes them especially comfortable to use. It means the packing tables can be infinitely adjusted at the touch of a button to the optimum height for fatigue-free working.



Packing table with hook rail

- With socket strip
- With drawer unit
- With double hook frame
- With plug GB



	Dimensions W × D × H mm	Product code
PT 1600/900/1589 GB	1600 × 900 × 1589	7506176



Packing table with top shelf

- With top shelf
- With socket strip
- With drawer unit
- With plug GB



	Dimensions W × D × H mm	Product code
PT mAR 3E 1200/650/850 GB	1200 × 650 × 850	7505797



Electrically height-adjustable packing table

- 50 mm anti-drip edge on all sides
- Thicker worktop: 1.5 mm
- 230 V electrical connection

	Dimensions W × D × H mm	Product code
PT-EH 1200/650/850-1150 GB	1200 × 650 × 850	7505798
PT-EH 1400/700/850-1150	1400 × 700 × 850	7504885
PT-EH 1600/650/850-1150 GB	1600 × 650 × 850	7505911
PT-EH 1600/700/850-1150	1600 × 700 × 850	7504843
PT-EH 1600/800/850-1150 GB	1600 × 800 × 850	7505867
PT-EH 1800/700/850-1150	1800 × 700 × 850	7504851
PT-EH 1800/900/850-1150 GB 001	1800 × 900 × 850	7505970
PT-EH 2000/700/850-1150	2000 × 700 × 850	7504842
PT-EH 2200/700/850-1150	2200 × 700 × 850	7504852



Packing and work tables

Mobile packing tables



Mobile packing table

- Thicker worktop: 1.5 mm
- 4 swivel castors (2 with central locks)

	Dimensions W × D × H mm	Product code
PT 1200/750/900 F 002	1200 × 750 × 900	7505947
PT 1447/750/900 F	1447 × 750 × 900	7500184
PT 1450/750/900 F 001	1447 × 765 × 907	7500461
PT 850/750/900 F m.s.Ha	850 × 750 × 900	7500216



Electrically height-adjustable packing table

- Thicker worktop: 1.5 mm
- 4 swivel castors (2 with central locks)
- 230 V electrical connection

	Dimensions W × D × H mm	Product code
PT-EH 1400/700/850-1150 F	1400 × 700 × 850	7504866
PT-EH 1600/700/850-1150 F	1600 × 700 × 850	7504881
PT-EH 1800/700/850-1150 F	1800 × 700 × 850	7504882
PT-EH 2000/700/850-1150 F	2000 × 700 × 850	7504883
PT-EH 2200/700/850-1150 F	2200 × 848 × 760	7504884
PT-EH/ZB-F 1400/700/850-1150 GB	1400 × 791 × 1747	7505963



Work tables

With their sturdy design and hard-wearing materials, Hupfer work tables show their special strengths even under the harshest conditions. Due to the sandwich design and stainless steel underside, their worktops are optimally vibration-free.



Work table

- Stainless steel tabletop with sandwich design
- Underside enclosed in stainless steel
- Height-adjustable plastic feet



	Dimensions W × D × H mm	Product code
AT-O 1000/750/850	1000 × 750 × 850	7504583
AT-O 1200/750/850	1200 × 750 × 850	7504584
AT-O 1500/750/850	1500 × 750 × 850	7504585



Work table with base shelf

- Stainless steel tabletop with sandwich design
- Welded base shelf
- Underside enclosed in stainless steel
- Height-adjustable plastic feet



	Dimensions W × D × H mm	Product code
AT-O/ZB 1000/750/850	1000 × 750 × 850	7504586
AT-O/ZB 1200/750/850	1200 × 750 × 850	7504587
AT-O/ZB 1500/750/850	1500 × 750 × 850	7504588
AT-O/ZB 2000/750/850	2000 × 750 × 850	7505912

Packing and work tables



Accessories for packing and work tables

Sturdy, versatile and expandable, packing tables can be used in many different departments. The electrohydraulic height adjustment makes them especially comfortable to use. It means the packing tables can be infinitely adjusted at the touch of a button to the optimum height for fatigue-free working.



Single hook frame for packing table

- With welded hooks
- Hook spacing: 350 mm
- Load per hook: 60 kg
- Compatible with hitch parts for hook systems



	Dimensions W × D × H mm	Product code
HL/1s 555/40/1447	556 × 41 × 1447	7500217
HL/2s 555/55/1447	555 × 55 × 1447	7500431



Double hook frame for packing table

- With welded hooks
- Hook spacing: 350 mm
- Load per hook: 60 kg
- Compatible with hitch parts for hook systems



	Dimensions W × D × H mm	Product code
HL/1s 1250/40/1447	1251 × 41 × 1447	7500185
HL/2s 1250/55/1447	1250 × 55 × 1447	7500430



Hook frame mounting set

- For table width up to 1400/1600 mm and from 1600 mm
- 1 set (holder left, holder right)
- Accommodates all hook frames
- To hang on 40x20 square tube



	Dimensions W × D × H mm	Product code
AufnHL 1400	496 × 131 × 1390	7504938
AufnHL 1600	298 × 106 × 483	7505599



Fastening set for hook frame

- For table tops with 15 mm projection
- For fastening to the table frame
- For table length from 1600 mm



	Product code
BFSa HL	7504850

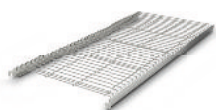

Norm 5 wired shelf

- Well ventilated storage
- Perfect hygiene
- High weight capacity
- Easy handling



	Dimensions W × D × H mm	Product code
A-DR/N5 1400/400	1400 × 340 × 49	0101892
A-DR/N5 1400/600	1400 × 540 × 49	0101922
A-DR/N5 800/400	800 × 340 × 49	0101612
A-DR/N5 800/600	800 × 540 × 49	0101642

Packing and work tables



Norm 5 solid shelf

- Easy to clean
- Perfect hygiene
- High weight capacity
- Easy handling

	Dimensions W × D × H mm	Product code
A-GS/N5 1400/400	1400 × 340 × 49	0102792
A-GS/N5 1400/600	1400 × 540 × 49	0102822
A-GS/N5 800/400	800 × 340 × 40	0102512
A-GS/N5 800/600	800 × 540 × 40	0102542



Light tables

Light tables



Light table

- Precise viewing option
- Shadow-free illumination
- Maximum flexibility
- Optimum hygiene



	Dimensions W × D × H mm	Product code
LT 1800/800/900	1800 × 800 × 900	7505790
LT 1800/800/900 GB	1800 × 812 × 900	7505829



Light table with base shelf

- Precise viewing option
- Shadow-free illumination
- Maximum flexibility
- Optimum hygiene



	Dimensions W × D × H mm	Product code
LT 1800/1100/900 GB 1GA	1800 × 1112 × 900	7506175



Mobile light table

- Precise viewing option
- Shadow-free illumination
- Maximum flexibility
- Optimum hygiene



	Dimensions W × D × H mm	Product code
LT 1800/1100/900 F GB	1800 × 1100 × 900	7505956

Sink units

Sink units



Sink unit with 1 basin and base shelf

- High weight capacity and safe standing
- Sound insulation for better acoustics
- perfect hygiene

	Dimensions W × D × H mm	Product code
ST AH150 1B 1ZB 1200/700/900	1200 × 700 × 900	7505851
ST AH150 1B 1ZB 1200/700/900 001	1200 × 700 × 900	7506196



Sink unit with 1 basin, 1 pre-rinse unit, 2 double-wing door cabinets

- High weight capacity and safe standing
- Sound insulation for better acoustics
- perfect hygiene

	Dimensions W × D × H mm	Product code
ST AH150 2FT-S 1B 1800/700/900	1800 × 700 × 900	7503857



Sink unit with 1 basin – electrically height-adjustable

- High weight capacity and safe standing
- Sound insulation for better acoustics
- perfect hygiene

	Dimensions W × D × H mm	Product code
ST-EH 2200/700/850-1150	2200 × 700 × 1150	7505746



Sink unit with 2 basins

- High weight capacity and safe standing
- Sound insulation for better acoustics
- Perfect hygiene



	Dimensions W × D × H mm	Product code
ST AH50 2B 1600/700/900	1600 × 700 × 900	7505742
ST AH50 2B 2000/700/900	2000 × 700 × 900	7505765
ST AH50 2B 2000/700/900 001	2000 × 700 × 900	7506195



Sink unit with 2 basins, 2 pre-rinse units, 2 double-wing door cabinets

- High weight capacity and safe standing
- Sound insulation for better acoustics
- Perfect hygiene



	Dimensions W × D × H mm	Product code
ST AH600 2FT-S 2B 2100/700/900	2100 × 700 × 900	7503860



Sink unit with 2 basins, 4 double-door cabinets, 2 drawers

- High weight capacity and safe standing
- Sound insulation for better acoustics
- Perfect hygiene



	Dimensions W × D × H mm	Product code
ST AH150 4FT-S 2SB 2B 2200/700/850	2200 × 700 × 850	7505796



Sink unit with 2 basins, without taps – electrically height-adjustable

- High weight capacity and safe standing
- Sound insulation for better acoustics
- perfect hygiene



	Dimensions W × D × H mm	Product code
ST-EH AH150 2B 2100/800/850-1150	2100 × 800 × 850	7506259

Sink units



Sink unit with 3 basins, 3 pre-rinse units

- High weight capacity and safe standing
- Sound insulation for better acoustics
- perfect hygiene

	Dimensions W × D × H mm	Product code
ST AH100 3B 3000/650/1000	3000 × 650 × 1000	7505826



Cabinets

Tall cabinets



Tall cabinet with hinged door and intermediate shelves



- For sterile and consumer goods
- Hinged door with all-round lip seal
- Extended storage time due to optimal protection against dust and light
- With height-adjustable base shelves
- Maximum capacity and tool-free height adjustment

	Dimensions W × D × H mm	Product code
MF-SR-HO-FLT/1000x650x2000	1000 × 708 × 2007	7506318
MF-SR-HO-FLT/1100x650x2000	1100 × 708 × 2007	7506317
MF-SR-HO-FLT/1200x650x2000	1200 × 708 × 2007	7506316
MF-SR-HO-FLT/300x650x2000	708 × 300 × 2007	7506325
MF-SR-HO-FLT/400x650x2000	708 × 400 × 2007	7506324
MF-SR-HO-FLT/500x650x2000	708 × 500 × 2007	7506323
MF-SR-HO-FLT/600x650x2000	708 × 600 × 2007	7506322
MF-SR-HO-FLT/700x650x2000	708 × 700 × 2007	7506321
MF-SR-HO-FLT/800x650x2000	800 × 708 × 2007	7506320
MF-SR-HO-FLT/900x650x2000	900 × 708 × 2007	7506319



Tall cabinet with hinged door, viewing window and intermediate shelves



- For sterile and consumer goods
- Viewing window for easy identification
- With height-adjustable base shelves
- Maximum capacity and tool-free height adjustment

	Dimensions W × D × H mm	Product code
MF-SR-HO-FLT/1000x674x2250	1000 × 712 × 2250	7505822

Cabinets



Tall cabinet with Medidul system

- Space-saving storage of StU and ISO baskets
- With Hupfer Medidul system
- Tool-less height-adjustable support rails
- Hinged door with all-round lip seal
- Extended storage time due to optimal protection against dust and light



	Dimensions W × D × H mm	Product code
MF-SR-HO-ISO MEDIDUL/1100x650x2000	1100 × 708 × 2007	7506382
MF-SR-HO-ISO MEDIDUL/600x650x2000	708 × 600 × 2007	7506381
MF-SR-HO-STE MEDIDUL/1200x650x2000	1200 × 708 × 2007	7506385
MF-SR-HO-STE MEDIDUL/500x650x2000	708 × 500 × 2007	7506383
MF-SR-HO-STE MEDIDUL/800x650x2000	800 × 708 × 2007	7506384



Tall cabinet for modular system

- Standardised storage according to ISO standard
- For sterile goods, medicines, instruments and accessories
- Clear storage and easy removal
- Hinged door with all-round lip seal
- Extended storage time due to optimal protection against dust and light



	Dimensions W × D × H mm	Product code
MF-SR-HO-MT/SM-G/L/938x650x2000	938 × 708 × 2007	7506393
MF-SR-HO-MT/SM-K/L/485x650x2000	708 × 485 × 2007	7506395

Tall cabinet elements



Side panel for tall cabinets

- For MediFurn tall cabinets

	Product code
MF-SR-SVli-HO/650x2000	7506336
MF-SR-SVre-HO/650x2000	7506337



Solid intermediate shelf

- For MediFurn tall cabinets
- For the appropriate division of the storage space
- Incl. support bolts and cover caps

	Dimensions W × D × H mm	Product code
MF-ZWB-GS/1000x565x40	1000 × 565 × 40	7506328
MF-ZWB-GS/1100x565x40	1100 × 565 × 40	7506327
MF-ZWB-GS/1200x565x40	1200 × 565 × 40	7506326
MF-ZWB-GS/300x565x40	565 × 300 × 40	7506335
MF-ZWB-GS/400x565x40	565 × 400 × 40	7506334
MF-ZWB-GS/500x565x40	565 × 500 × 40	7506333
MF-ZWB-GS/600x565x40	600 × 565 × 40	7506332
MF-ZWB-GS/700x565x40	700 × 565 × 40	7506331
MF-ZWB-GS/800x655x40	800 × 655 × 40	7506330
MF-ZWB-GS/900x565x40	900 × 565 × 40	7506329

Cabinets



Flat top

- For MediFurn tall cabinets
- for perfect hygiene

	Dimensions W × D × H mm	Product code
MF-SR-FD-HO/1000x650x50	1000 × 650 × 50	7506340
MF-SR-FD-HO/1100x650x50	1100 × 650 × 50	7506339
MF-SR-FD-HO/1200x650x50	1200 × 650 × 50	7506338
MF-SR-FD-HO/300x650x50	650 × 300 × 50	7506347
MF-SR-FD-HO/400x650x50	650 × 400 × 50	7506346
MF-SR-FD-HO/500x650x50	650 × 500 × 50	7506345
MF-SR-FD-HO/600x650x50	650 × 600 × 50	7506344
MF-SR-FD-HO/700x650x50	700 × 650 × 50	7506343
MF-SR-FD-HO/800x650x50	800 × 650 × 50	7506342
MF-SR-FD-HO/900x650x50	900 × 650 × 50	7506341



Inclined top

- for MediFurn tall cabinets
- 20° incline
- for perfect hygiene

	Dimensions W × D × H mm	Product code
MF-SR-SD-HO/WHS-20/1000x650x284	1000 × 650 × 284	7506350
MF-SR-SD-HO/WHS-20/1100x650x284	1100 × 650 × 284	7506349
MF-SR-SD-HO/WHS-20/1200x650x284	1200 × 650 × 284	7506348
MF-SR-SD-HO/WHS-20/300x650x284	650 × 300 × 284	7506357
MF-SR-SD-HO/WHS-20/400x650x284	650 × 400 × 284	7506356
MF-SR-SD-HO/WHS-20/500x650x284	650 × 500 × 284	7506355
MF-SR-SD-HO/WHS-20/600x650x284	650 × 600 × 284	7506354
MF-SR-SD-HO/WHS-20/700x650x284	700 × 650 × 284	7506353
MF-SR-SD-HO/WHS-20/800x650x284	800 × 650 × 284	7506352
MF-SR-SD-HO/WHS-20/900x650x284	900 × 650 × 284	7506351



Base frame

- for MediFurn tall cabinets
- Further sizes are available on request

	Dimensions W × D × H mm	Product code
MF-SR-SO/1000x650x100	1000 × 650 × 100	7506360
MF-SR-SO/1100x650x100	1100 × 650 × 100	7506359
MF-SR-SO/1200x650x100	1200 × 650 × 100	7506358
MF-SR-SO/300x650x100	650 × 300 × 100	7506367
MF-SR-SO/400x650x100	650 × 400 × 100	7506366
MF-SR-SO/500x650x100	650 × 500 × 100	7506365
MF-SR-SO/600x650x100	650 × 600 × 100	7506364
MF-SR-SO/700x650x100	700 × 650 × 100	7506363
MF-SR-SO/800x650x100	800 × 650 × 100	7506362
MF-SR-SO/900x650x100	900 × 650 × 100	7506361



Base cover

- Magnetically fixed for easy maintenance
- for Medidul cabinets
- 100 mm high
- Further sizes are available on request

	Dimensions W × D × H mm	Product code
MF-SR-SO-B/1000x20x100	1000 × 20 × 100	7506370
MF-SR-SO-B/1100x20x100	1100 × 20 × 100	7506369
MF-SR-SO-B/1200x20x100	1200 × 20 × 100	7506368
MF-SR-SO-B/300x20x100	300 × 20 × 100	7506378
MF-SR-SO-B/400x20x100	400 × 20 × 100	7506377
MF-SR-SO-B/500x20x100	500 × 20 × 100	7506376
MF-SR-SO-B/600x20x100	600 × 20 × 100	7506375
MF-SR-SO-B/650x20x100	650 × 20 × 100	7506374
MF-SR-SO-B/700x20x100	700 × 20 × 100	7506373
MF-SR-SO-B/800x20x100	800 × 20 × 100	7506372
MF-SR-SO-B/900x20x100	900 × 20 × 100	7506371

Cabinets

Push-through cupboards

The Hupfer push-through cupboard act as a barrier for the intermediate storage of goods between clean and unclean areas, as well as for delivering sterile supplies and disposing of contaminated material on Hupfer transport carts.

The stable, self-supporting and hygienic structure made of high-quality stainless steel consists of a fully enclosed housing, with two double-walled wing doors each on the clean and the unclean sides. An electromagnetic door lock prevents the doors to the clean and unclean sides from being open at the same time. Red indicator lights indicate open doors on the opposite side, and there are green buttons to release the doors underneath, provided the doors on the opposite side are closed.



Push-through cupboards

- Electrical interlock

	Dimensions W × D × H mm	Product code
DRS 6StE 1150/900/1800	1150 × 900 × 1800	7504604
DRS 9StE 1435/900/1800	1435 × 900 × 1800	7504605



Operating theatre steps



Operating theatre steps

With their sturdy construction and contoured non-slip surfaces, Hupfer operating room steps give a firm foothold for the ideal position in relation to the patient. The steps and frame are firmly screwed and can be dismantled for cleaning. The steps are of a uniform height with no overlap and are electrically conductive to ensure additional safety in the operating room. Hupfer operating room steps thus meet all the requirements of DIN EN 14183.

The Hupfer hook trolley for operating room steps is ideal for storage. Instead of the usual stacked storage, the steps are placed on separate brackets and can be easily removed as required.



Operating theatre step – single step

- Bolted steps and frame
- Non-slip tread
- Anti-slip stand
- Electrically conductive



	Dimensions W × D × H mm	Product code
OP-A 600/350/130	600 × 350 × 130	7500294
OP-A 600/350/220	600 × 350 × 220	7500295
OP-A 600/350/300	600 × 350 × 300	7500296



Operating theatre step – double step

- Bolted steps and frame
- Non-slip tread
- Anti-slip stand
- Electrically conductive



	Dimensions W × D × H mm	Product code
OP-A 600/680/220-440	680 × 600 × 440	7500297

Hygiene range



Hygiene range

Optimum hygiene is of the utmost importance in every clinic, hospital and sterilisation facility. However different the many types of task and work processes are, The Hupfer hygiene programme allows hand hygiene and disinfection everywhere to provide optimum safety for employees, patients and visitors.



Soap dispenser – 500 ml

- For interchangeable bottles
- Lockable



	Dimensions W x D x H mm	Product code
TC1-13 109/71/301	109 x 71 x 301	8600004



Soap dispenser – 950 ml

- For interchangeable bottles
- Lockable



	Dimensions W x D x H mm	Product code
TC1-01 120/76/298	120 x 76 x 298	8600025



Soap/disinfectant dispenser

- For free filling
- Load capacity: 1000 ml
- Stainless steel

	Dimensions W × D × H mm	Product code
SDMS Typ I-1000	195 × 99 × 305	8600129



Hand wash basin

- Knee-operated
- With rear panel and tap
- Not for pressureless water heaters with three lines

	Dimensions W × D × H mm	Product code
EWB	400 × 310 × 560	8200342



Towel dispenser 300

- With vision panel
- Opening by bolt lock

	Dimensions W × D × H mm	Product code
TC1-14 126/300/308	300 × 126 × 308	8600006



Towel dispenser 500

- With vision panel
- Opening by bolt lock

	Dimensions W × D × H mm	Product code
TC1-03 120/298/298	298 × 120 × 298	8600022

Hygiene range



Waste paper basket

- Free-standing or wall mounting

	Dimensions W × D × H mm	Product code
PaKo 340/265/425	340 × 265 × 425	8600029



Waste and laundry collector



Hupfer waste and laundry collectors ensure safe, economical processes from sorting and treatment to the professional disposal of critical materials. The extensive product range allows solutions to be tailored to the specific situation and requirements.



Waste/laundry collector

Waste/laundry collector

Hupfer waste and laundry collectors make disposal tasks very easy to carry out. This is ensured by the stable construction, different versions for various requirements and easy and safe manoeuvring on smooth-running castors.



Waste/laundry collector – 1 compartment

- 1 compartment
- With rubber ring
- Stainless steel



	Dimensions W × D × H mm	Product code
SWA-1	450 × 350 × 905	7501091



Waste/laundry collector – 2 compartment

- 2 compartments
- With rubber ring
- Stainless steel



	Dimensions W × D × H mm	Product code
SWA-2	680 × 450 × 905	7501092



Waste/laundry collector – 3 compartment

- 3 compartments
- With rubber ring
- Stainless steel



	Dimensions W × D × H mm	Product code
SWA-3	1010 × 450 × 905	7501093



Waste/laundry collector – 1 compartment with foot pedal and lid

- With foot pedal and lid
- 1 compartment
- With rubber ring
- Stainless steel



	Dimensions W × D × H mm	Product code
SWAF-1	496 × 350 × 913	0163920



Waste/laundry collector – 2 compartment with foot pedal and lid

- With foot pedal and lid
- 2 compartments
- With rubber ring
- Stainless steel



	Dimensions W × D × H mm	Product code
SWAF-2	680 × 496 × 913	0163921



Waste/laundry collector – 3 compartment with foot pedal and lid

- With foot pedal and lid
- 3 compartments
- With rubber ring
- Stainless steel



	Dimensions W × D × H mm	Product code
SWAF-3	1010 × 496 × 913	0163922

Theatre laundry/waste collector

Theatre laundry/waste collector

Operating rooms place special demands on equipment and devices in clinics and hospitals. Hupfer operating room laundry/waste collectors are optimally tailored to this in their function and design, right up to their electrically conductive castors.



Theatre laundry/waste collector – 1 compartment

- 1 compartment
- With holding frame for laundry bag
- Secure clamping of bags/nets
- Antistatic castors



	Dimensions W × D × H mm	Product code
OP-SWA-1 350/450/901	450 × 350 × 905	7500711



Theatre laundry/waste collectors – 2 compartment

- 2 compartments
- With holding frame for laundry bag
- Secure clamping of bags/nets
- Antistatic castors



	Dimensions W × D × H mm	Product code
OP-SWA-2 680/450/901	680 × 450 × 905	7500712

Accessories for theatre laundry/waste collectors

Accessories for theatre laundry/waste collectors



Lid for collector

- With foot pedal
- Polystyrene
- White

	Dimensions W × D × H mm	Product code
De 290/400/25	400 × 290 × 25	7501008
De 290/421/25	421 × 290 × 25	7501009



Lid for collector without pedal

- Without foot pedal
- Polystyrene
- White

	Dimensions W × D × H mm	Product code
De 290/400/25	447 × 290 × 25	7501679
De 290/400/60	400 × 290 × 60	7500261



Lid for collector with fixing set

- Durable
- easy application
- Simple opening and closing

	Dimensions W × D × H mm	Product code
De 290/450/60	450 × 290 × 104	7500723

Accessories for theatre laundry/waste collectors



Rubber ring

	Dimensions W × D × H mm	Product code
Aufspann-Gummiring 350x250x42	350 × 250 × 42	7500260

Highly recommended: the knowledge and experience of our experts

We are always happy to help

Presented by

Our general terms and conditions apply, which can be viewed at www.hupfer.com/de/avb

All data/dimensions are approximate. Subject to technical changes.

All images are examples, without decoration, and may include special equipment.

Colours may vary.

Hupfer Metallwerke GmbH & Co. KG
Dieselstraße 20 · 48653 Coesfeld
Postfach 14 63 · 48634 Coesfeld
Tel.: +49 2541 805-0
Fax: +49 2541 805-111
info@hupfer.com · www.hupfer.com

*Satzdruck 10/23. All data/dimensions are approximate. Subject to technical changes.
Not to be reproduced in any form, whether in part or in full, without prior permission.
All images are examples, without decoration, and may include special equipment.*